

LEDasaA⁺

LED OUTDOOR LIGHT



ΑΝΤΡΕ ΑΝΩΝΥΜΟΣ ΕΜΠΟΡΙΚΗ &
ΒΙΟΜΗΧΑΝΙΚΗ
ΕΤΑΙΡΕΙΑ ΗΛΕΚΤΡΟΝΙΚΩΝ ΜΕΣΩΝ
ΕΛ ΒΕΝΙΖΕΑΟΥ 29 — 14565 ΑΓ ΣΤΕΦΑΝΟΣ
ΤΗΛ ΚΕΝΤΡΟ 210-8140050-FAX : 210-6218640

40⁺re
ΧΡΟΝΙΑ

CONTENTS

LED Street Light	P01-P23
Led Street Light Pole Connected Bracket	P24
LED Flood Light	P25-P42
LED Canopy Light	P74-P86

LED Work Light	P43-P56
LED Highbay Light	P57-P68
LED Stadium Light	P69-P73

MODULARIZATION STREET LIGHT



1. Originate and Unique electronic connector design up to now .
Easy for maintaining and replacement .
2. IP67 Level protection
3. Power from 60W up to 300W
4. Luminaire lighting efficacy 130Lm/w up to 160Lm/w

LED Street Light

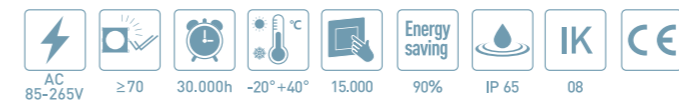
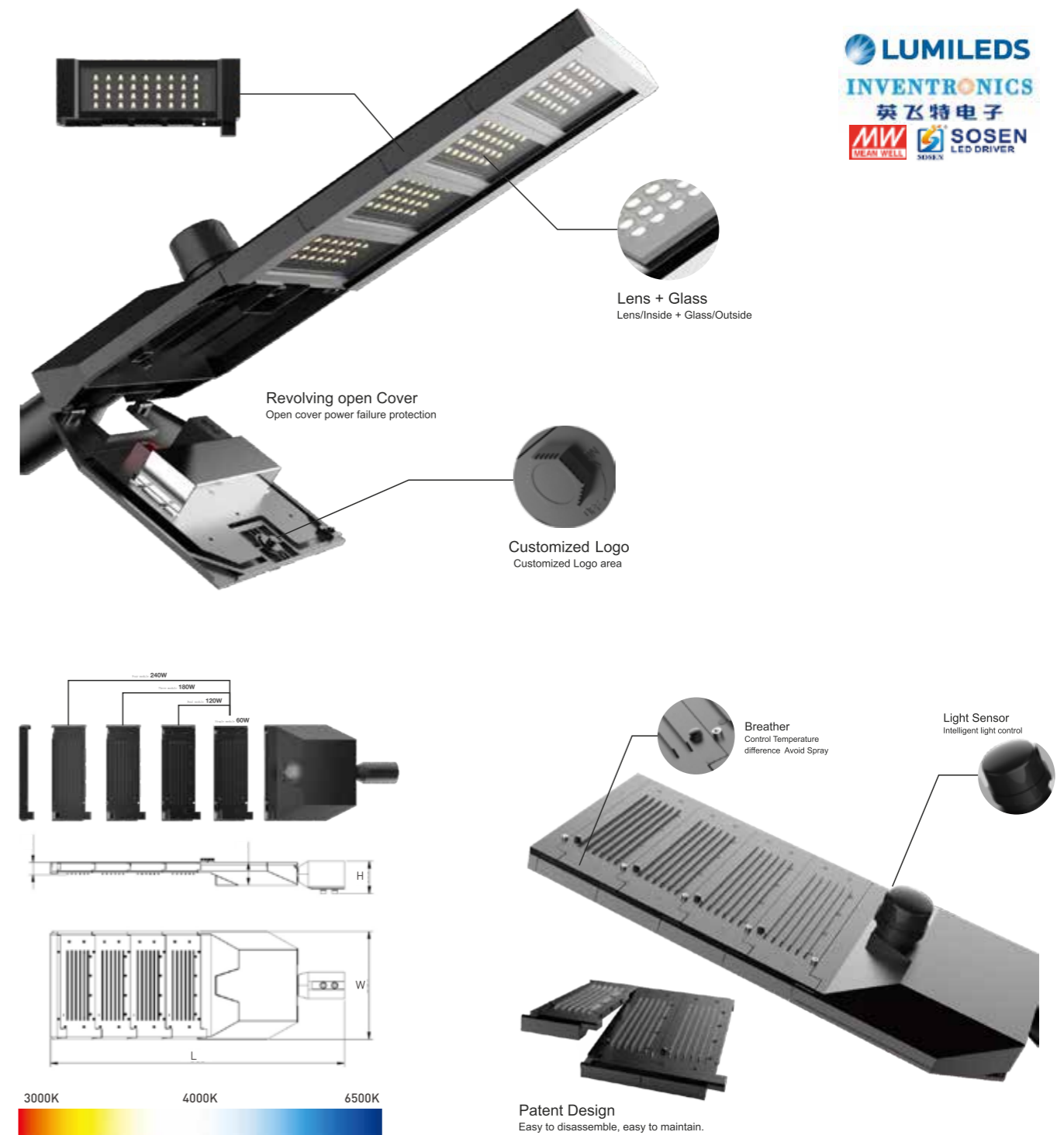

ITEM NO.	Wattage [W]	LED	Lumen [lm]	Beam angle	Power Factor	Material	Pole Size [mm]	Size [mm]
LED-SLS-60W	60W	SMD3030	9000	80*150°	>0,9	Aluminum	60	578*337*101
LED-SLS-120W	120W	SMD3030	18000	80*150°	>0,9	Aluminum	60	685*337*101
LED-SLS-180W	180W	SMD3030	27000	80*150°	>0,9	Aluminum	60	793*337*101
LED-SLS-240W	240W	SMD3030	36000	80*150°	>0,9	Aluminum	60	900*337*101

LED Street Light



Photocell sensor unit(option), according to environmental illumination to auto control turn on/off, energy saving and environmental protection.

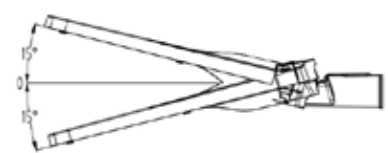
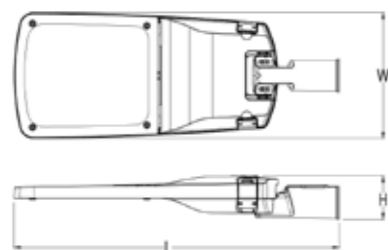

ITEM NO.	Wattage [W]	LED	Lumen [lm]	Beam angle	Power Factor	Material	Pole Size [mm]	Size [mm]
LED-SLA-60W	60W	SMD3030	7800	120°	>0.9	Aluminum	60	577*232,6*103,2
LED-SLA-100W	100W	SMD3030	13000	120°	>0.9	Aluminum	60	627*271,5*103,2
LED-SLA-200W	200W	SMD3030	26000	120°	>0.9	Aluminum	60	768*301*103,5

LED Street Light



Photocell sensor unit(option), according to environmental illumination to auto control turn on/off, energy saving and environmental protection.

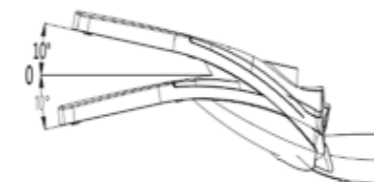
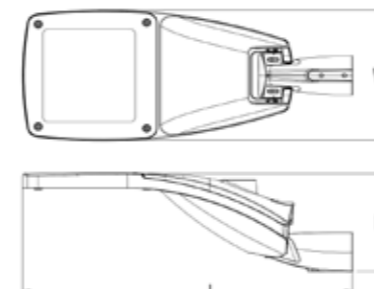

ITEM NO.	Wattage [W]	LED	Lumen [lm]	Beam angle	Power Factor	Material	Pole Size [mm]	Size [mm]
LED-SLAF-100W	100W	SMD3030	13000	120°	>0.9	Aluminum	60	699*269*203
LED-SLAF-200W	200W	SMD3030	26000	120°	>0.9	Aluminum	60	739*308*207



LED Street Light

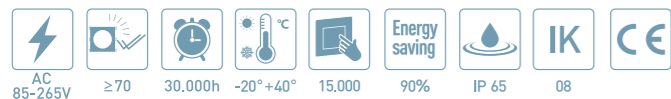
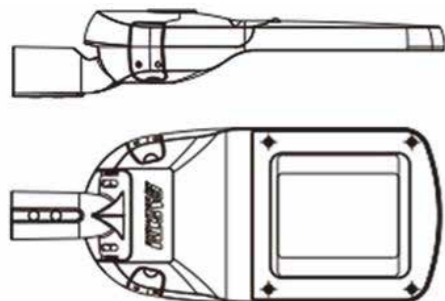

Item No.	Wattage [W]	LED	Lumen [lm]	Beam angle	Power Factor	Material	Pole Size [mm]	Size [mm]
LED-SLB-50W	50W	SMD3030	6000	60°/120°	>0.9	Aluminum	48	508*214*122
LED-SLB-100W	100W	SMD3030	12500	60°/120°	>0.9	Aluminum	60	608*234*122
LED-SLB-150W	150W	SMD3030	18750	60°/120°	>0.9	Aluminum	60	673*260*122
LED-SLB-220W	220W	SMD3030	27500	60°/120°	>0.9	Aluminum	60	794*320*122

LED Street Light

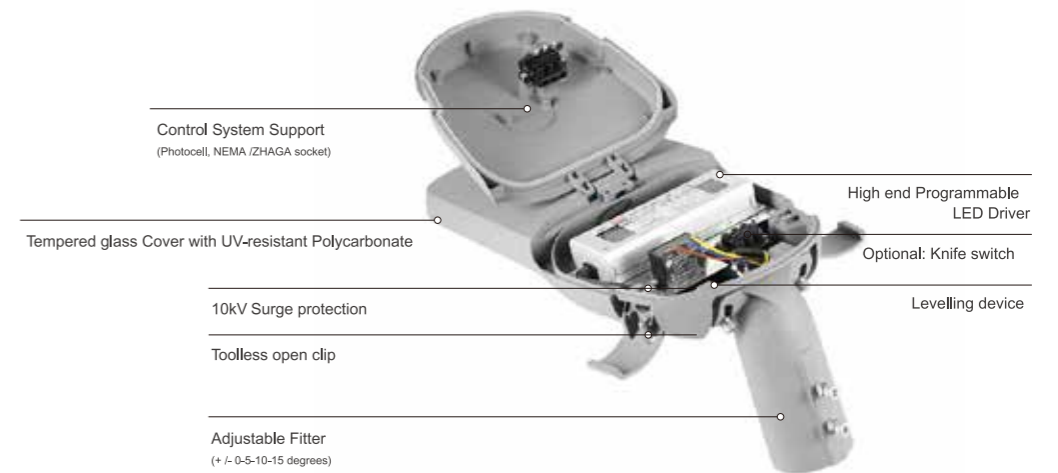

Item No.	Wattage [W]	LED	Lumen [lm]	Beam angle	Power Factor	Material	Pole Size [mm]	Size [mm]
LED-SLC-60W	60W	SMD3030	7800	120°	>0.9	Aluminum	60	621*287*105
LED-SLC-100W	100W	SMD3030	13000	120°	>0.9	Aluminum	60	738*289*118
LED-SLC-200W	200W	SMD3030	36000	120°	>0.9	Aluminum	60	922*362*140

LED Street Light



3000K 4000K 6500K

AC 180-265V ≥80 30,000h -20°+40° 15,000 90%

Energy saving CE

Item No.	Wattage [W]	LED	Lumen [lm]	Beam angle	Power Factor	Material	Pole Size [mm]	Size [mm]
LED-SLG-30W(A/B)	30W	SMD3030	3900	Type II / TypeIII	>0.9	Aluminum	Ø60	563.5*165*110
LED-SLG-40W(A/B)	40W	SMD3030	5200	Type II / TypeIII	>0.9	Aluminum	Ø60	563.5*165*110
LED-SLG-50W(A/B)	50W	SMD3030	6500	Type II / TypeIII	>0.9	Aluminum	Ø60	563.5*165*110
LED-SLG-60W(A/B)	60W	SMD3030	7800	Type II / TypeIII	>0.9	Aluminum	Ø60	563.5*165*110
LED-SLG-80W(A/B)	80W	SMD3030	10400	Type II / TypeIII	>0.9	Aluminum	Ø60	651*216*111
LED-SLG-100W(A/B)	100W	SMD3030	13000	Type II / TypeIII	>0.9	Aluminum	Ø60	651*216*111
LED-SLG-120W(A/B)	120W	SMD3030	15600	Type II / TypeIII	>0.9	Aluminum	Ø60	651*216*111
LED-SLG-150W(A/B)	150W	SMD3030	19500	Type II / TypeIII	>0.9	Aluminum	Ø60	836*266*138
LED-SLG-180W(A/B)	180W	SMD3030	23400	Type II / TypeIII	>0.9	Aluminum	Ø60	836*266*138
LED-SLG-200W(A/B)	200W	SMD3030	26000	Type II / TypeIII	>0.9	Aluminum	Ø60	836*266*138

LED Street Light

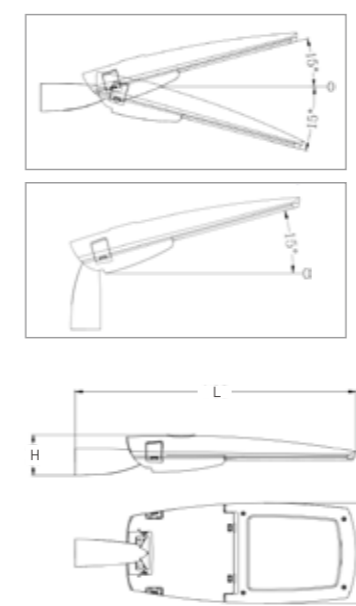

3000K 4000K 6500K

AC 85-265V ≥70 30,000h -20°+40° 15,000 90% IP 65 08

Energy saving CE

Item No.	Wattage [W]	LED	Lumen [lm]	Beam angle	Power Factor	Material	Pole Size [mm]	Size [mm]
LED-SLC-60W	60W	SMD3030	7800	120°	>0.9	Aluminum	60	621*287*105
LED-SLC-100W	100W	SMD3030	13000	120°	>0.9	Aluminum	60	738*289*118
LED-SLC-200W	200W	SMD3030	36000	120°	>0.9	Aluminum	60	922*362*140



LED Street Light

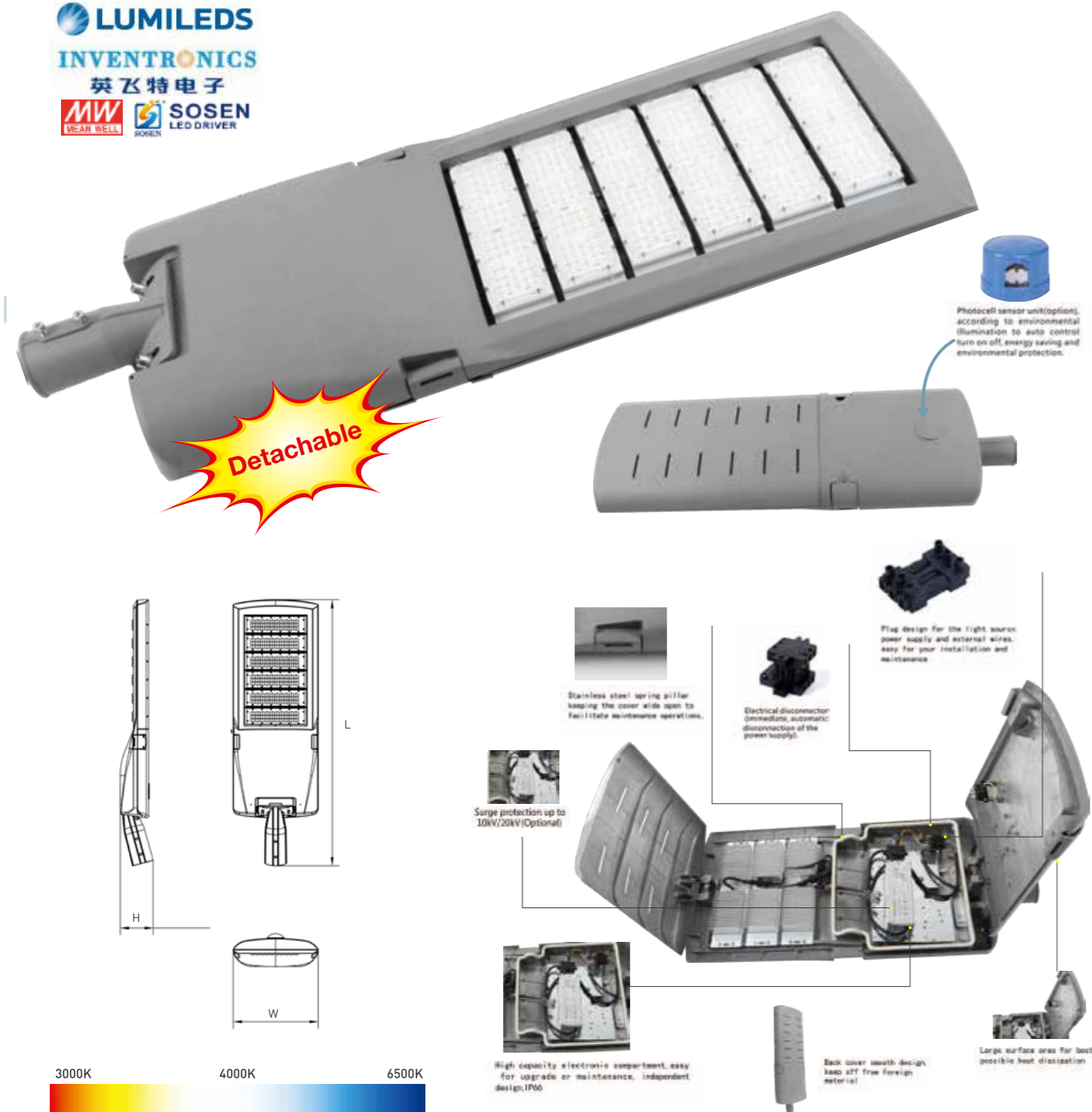

ITEM NO.	Wattage [W]	LED	Lumen [lm]	Beam angle	Power Factor	Material	Pole Size [mm]	Size [mm]
LED-SLM-100W	100W	SMD3030	13000	120°	>0.9	Aluminum	60	718*371*140
LED-SLM-150W	150W	SMD3030	19500	120°	>0.9	Aluminum	60	798*371*140
LED-SLM-200W	200W	SMD3030	26000	120°	>0.9	Aluminum	60	878*371*140
LED-SLM-250W	250W	SMD3030	32500	120°	>0.9	Aluminum	60	958*371*140
LED-SLM-300W	300W	SMD3030	39000	120°	>0.9	Aluminum	60	1038*371*140

LED Street Light

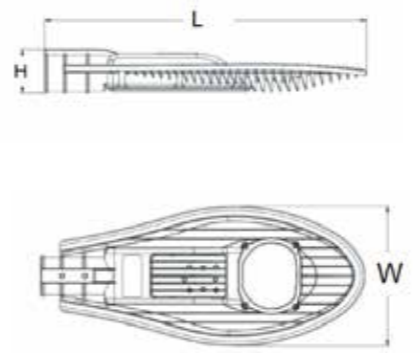

Item No.	Wattage [W]	LED	Lumen [lm]	Beam angle	Power Factor	Material	Pole Size [mm]	Size [mm]
LED-SLD-50W	50W	1*COB	5000	120°	>0.9	Aluminum	60	500*214*60
LED-SLD-100W	100W	2*COB	10000	120°	>0.9	Aluminum	60	720*276*80
LED-SLD-150W	150W	3*COB	15000	120°	>0.9	Aluminum	60	850*325*90
LED-SLD-200W	200W	4*COB	20000	120°	>0.9	Aluminum	60	950*350*110

LED Street Light

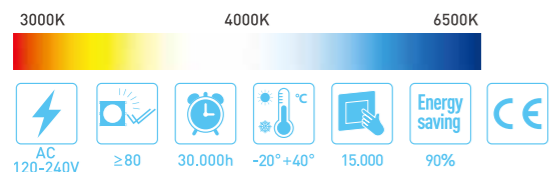
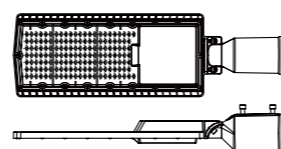
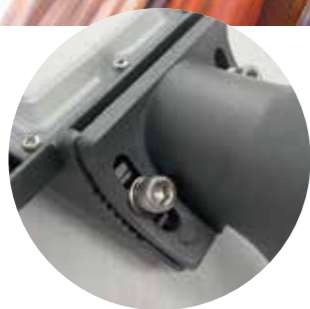

Item No.	Wattage [W]	LED	Lumen [lm]	Beam angle	Power Factor	Material	Pole Size [mm]	Size [mm]
LED-YSK-50W	50W	SMD2835	6000	Type II	>0,9	Aluminum	Ø60	340*121*38
LED-YSK-100W	100W	SMD2835	12000	Type II	>0,9	Aluminum	Ø60	449*162*38
LED-YSK-150W	150W	SMD2835	18000	Type II	>0,9	Aluminum	Ø60	623*200*51
LED-YSK-200W	200W	SMD2835	24000	Type II	>0,9	Aluminum	Ø60	783*260*83

LED Street Light



A

B

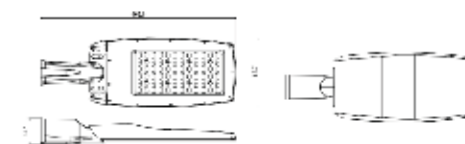
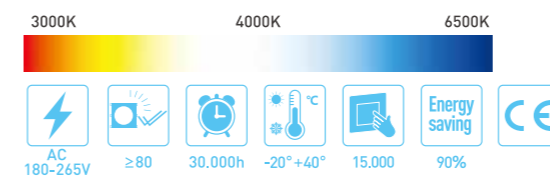

Item No.	Wattage [W]	LED	Lumen [lm]	Beam angle	Power Factor	Material	Pole Size [mm]	Size [mm]
LED-SH-30W(A/B)	30W	SMD3030	3000	Type II	>0,9	Aluminum	Ø48	399*149*63
LED-SH-50W(A/B)	50W	SMD3030	5000	Type II	>0,9	Aluminum	Ø48	469*168*63
LED-SH-60W(A/B)	60W	SMD3030	6000	Type II	>0,9	Aluminum	Ø48	469*168*63
LED-SH-100W(A/B)	100W	SMD3030	10000	Type II	>0,9	Aluminum	Ø60	508*237*76
LED-SH-150W(A/B)	150W	SMD3030	15000	Type II	>0,9	Aluminum	Ø60	559*287*74

LED Street Light

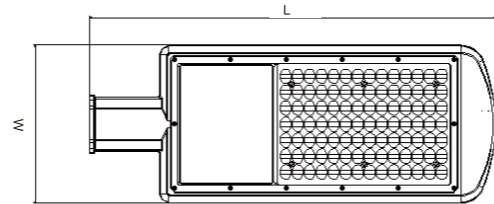

3000K 4000K 6500K

AC 85-265V ≥70 30,000h -20°+40° 15,000 90% IP 65

Energy saving

ITEM NO.	Wattage [W]	LED	Lumen [lm]	Beam angle	Material	Pole Size [mm]	Size [mm]
LED-SE-20W	20W	SMD3030	2000	70*140°	Aluminum	40	261*110*56
LED-SE-30W	30W	SMD3030	3000	70*140°	Aluminum	40	311*136*56
LED-SE-50W	50W	SMD3030	5000	70*140°	Aluminum	48	391*162*67
LED-SE-80W	80W	SMD3030	8000	70*140°	Aluminum	60	482*187*80
LED-SE-100W	100W	SMD3030	10000	70*140°	Aluminum	60	541*213*80

LED Street Light

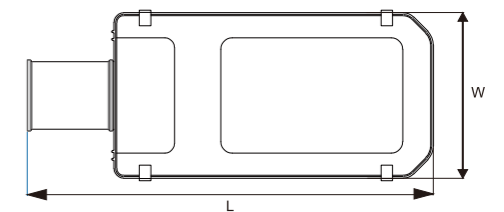

3000K 4000K 6500K

AC 85-265V ≥70 30,000h -20°+40° 15,000 90% IP 65

Energy saving

ITEM NO.	Wattage [W]	LED	Lumen [lm]	Beam angle	Power Factor	Material	Pole Size [mm]	Size [mm]
LED-SA-50W	50W	SMD3030	4000	120°	>0.9	Aluminum	60	423*179*56
LED-SA-100W	100W	SMD3030	8000	120°	>0.9	Aluminum	60	505*210*70
LED-SA-150W	150W	SMD3030	12000	120°	>0.9	Aluminum	60	640*240*70
LED-SA-200W	200W	SMD3030	16000	120°	>0.9	Aluminum	60	820*305*70

LED Street Light



3000K 4000K 6500K

AC 85-265V
 ≥70
 30,000h
 -20°+40°
 15,000
 Energy saving 90%
 IP 65

Item No.	Wattage [W]	LED	Lumen [lm]	Beam angle	Power Factor	Material	Pole Size[mm]	Size [mm]
LED-SD-20W	20W	SMD2835	2000	120°	>0.9	Aluminum	40	315*128*76
LED-SD-30W	30W	SMD2835	3000	120°	>0.9	Aluminum	40	351*142*76
LED-SD-50W	50W	SMD2835	5000	120°	>0.9	Aluminum	48	405*166*79
LED-SD-100W	100W	SMD2835	10000	120°	>0.9	Aluminum	60	484*211*83
LED-SD-150W	150W	SMD2835	15000	120°	>0.9	Aluminum	60	580*242*83

LED Street Light



3000K 4000K 6500K

AC 85-265V
 ≥70
 30,000h
 -20°+40°
 15,000
 Energy saving 90%
 IP 65



ITEM NO.	Wattage [W]	LED	Lumen [lm]	Beam angle	Power Factor	Material	Pole Size[mm]	Size [mm]
LED-SG-30W	30W	SMD3030	3000	120°	>0.5	Aluminum	48	390*120*50
LED-SG-50W	50W	SMD3030	5000	120°	>0.9	Aluminum	48	470*153*50
LED-SG-100W	100W	SMD3030	10000	120°	>0.9	Aluminum	48	540*173*50

LED Street Light



3000K 4000K 6500K

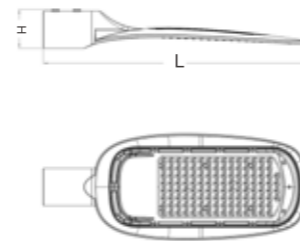
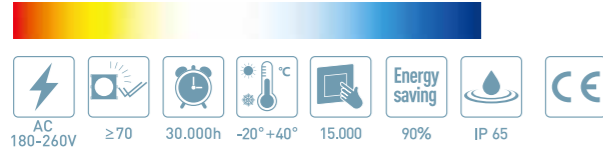

Item No.	Wattage [W]	LED	Lumen [lm]	Beam angle	Power Factor	Material	Pole Size [mm]	Size [mm]
LED-SF-50W	50W	SMD2835	5000	75°	>0.9	Aluminum	48	410*165
LED-SF-100W	100W	SMD2835	10000	75°	>0.9	Aluminum	60	500*200
LED-SF-150W	150W	SMD2835	15000	75°	>0.9	Aluminum	60	570*245
LED-SF-200W	200W	SMD2835	20000	75°	>0.9	Aluminum	60	630*285

LED Street Light



3000K 4000K 6500K

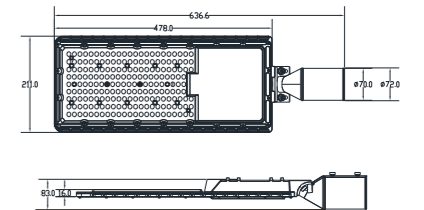
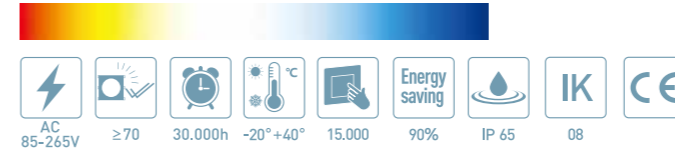

ITEM NO.	Wattage [W]	LED	Lumen [lm]	Beam angle	Power Factor	Material	Pole Size [mm]	Size [mm]
LED-YSK-50W	100W	SMD2835	6000	70*140°	>0.9	Aluminum+PC	60	500*160*38
LED-YSK-100W	100W	SMD2835	12000	70*140°	>0.9	Aluminum+PC	60	636.6*211*38
LED-YSK-150W	150W	SMD2835	18000	70*140°	>0.9	Aluminum+PC	60	675*255*83
LED-YSK-200W	200W	SMD2835	24000	70*140°	>0.9	Aluminum+PC	60	783*260*83

LED Street Light



3000K 4000K 6500K

AC 180-265V
 ≥80
 30,000h
 -20°+40°
 15,000
 Energy saving 90%
 CE

Item No.	Wattage [W]	LED	Lumen [lm]	Beam angle	Power Factor	Material	Pole Size [mm]	Size [mm]
LED-SJ-30W	30W	SMD2835	2700	90*130°	>0.9	Aluminum+PC	Ø48	438*128*88
LED-SJ-50W	50W	SMD2835	4500	90*130°	>0.9	Aluminum+PC	Ø48	486*151*88
LED-SJ-100W	100W	SMD2835	9000	90*130°	>0.9	Aluminum+PC	Ø48	564*189*88
LED-SJ-150W	150W	SMD2835	13500	90*130°	>0.9	Aluminum+PC	Ø60	638*210*97
LED-SJ-200W	200W	SMD2835	18000	90*130°	>0.9	Aluminum+PC	Ø60	695*235*97

LED Street Light

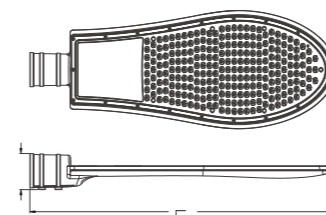

3000K 4000K 6500K

AC 180-260V
 ≥70
 30,000h
 -20°+40°
 15,000
 Energy saving 90%
 IP 65
 CE

Installation:

Note: before installation,
Only use a round cable supplied to connect this fitting. (6mm Diameter minimum.)

This is required in order to create a good water seal when connected to the fitting.

2-Connect the Main Line to the power wire of the lamp.

1-Fasten the adjustable bracket with stainless steel screws

4-Install the LED street lights in the pole and wall.

3-Ensure the terminal connection is made inside a suitable IP65 rated junction box (not included)

From Floodlight: L = Brown, N = Blue, PE = Green/Yellow

From IP65 Rated Junction Box: L = Brown or Red, N = Blue or Black, PE = Green/Yellow

ITEM NO.	Wattage [W]	LED	Lumen [lm]	Beam angle	Power Factor	Material	Pole Size [mm]	Size [mm]
LED-SB-30W	30W	SMD2835	2400	90°	>0.9	Aluminum	48	370*146*52
LED-SB-50W	50W	SMD2835	4000	90°	>0.9	Aluminum	48	435*164*52
LED-SB-100W	100W	SMD2835	8000	90°	>0.9	Aluminum	60	490*192*72
LED-SB-150W	150W	SMD2835	12000	90°	>0.9	Aluminum	60	572*210*76
LED-SB-200W	200W	SMD2835	16000	90°	>0.9	Aluminum	60	649*251*76

LED Street Light



LED Street Light

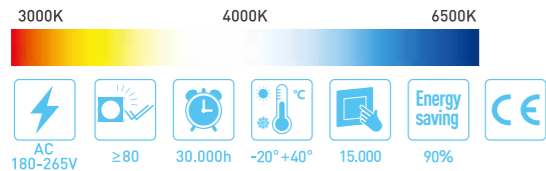

Item No.	Wattage [W]	LED	Lumen [lm]	Beam angle	Power Factor	Material	Pole Size [mm]	Size [mm]
LED-SI-30W	30W	SMD2835	3000	70*140°	>0.9	Aluminum	Ø40	320*135*58
LED-SI-50W	50W	SMD2835	5000	70*140°	>0.9	Aluminum	Ø48	377*147*68
LED-SI-100W	100W	SMD2835	10000	70*140°	>0.9	Aluminum	Ø60	500*185*80
LED-SI-150W	150W	SMD2835	15000	70*140°	>0.9	Aluminum	Ø60	585*210*80

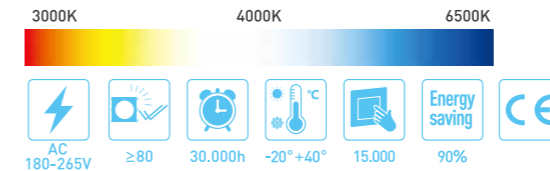

Item No.	Wattage [W]	LED	Lumen [lm]	Beam angle	Power Factor	Material	Pole Size [mm]	Size [mm]
LED-YSM-50W	50W	SMD2835	4000	70*140°	>0.9	Aluminum	Ø48	360*145*70
LED-YSM-100W	100W	SMD2835	8000	70*140°	>0.9	Aluminum	Ø48	485*165*70
LED-YSM-150W	150W	SMD2835	12500	70*140°	>0.9	Aluminum	Ø60	550*200*85
LED-YSM-200W	200W	SMD2835	16000	70*140°	>0.9	Aluminum	Ø60	620*235*85

LED Street Light

Led Street Light Pole Connected Bracket



Photocell sensor unit (optional), according to environmental illumination to auto control turn on/off, energy saving and environmental protection.

3000K 4000K 6500K

AC 85-265V ≥70 30,000h -20°+40° 15,000 90% IP 65 CE

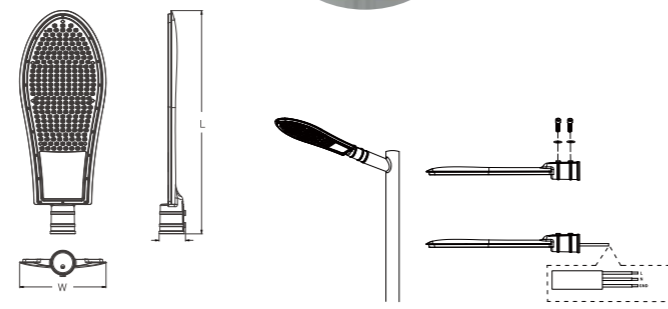

ITEM NO.	Wattage [W]	LED	Lumen [lm]	Beam angle	Power Factor	Material	Pole Size [mm]	Size [mm]
LED-SC-100W	100W	SMD3030	10000	70*140°	>0.9	Aluminum	40	560*203*79
LED-SC-150W	150W	SMD3030	15000	70*140°	>0.9	Aluminum	40	670*215*80
LED-SC-200W	200W	SMD3030	20000	70*140°	>0.9	Aluminum	40	725*240*80

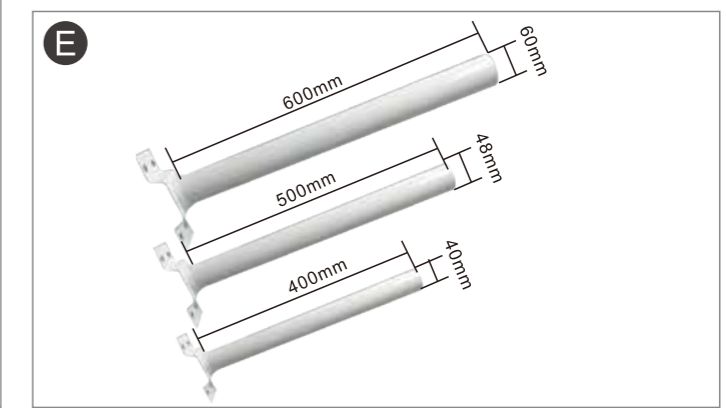
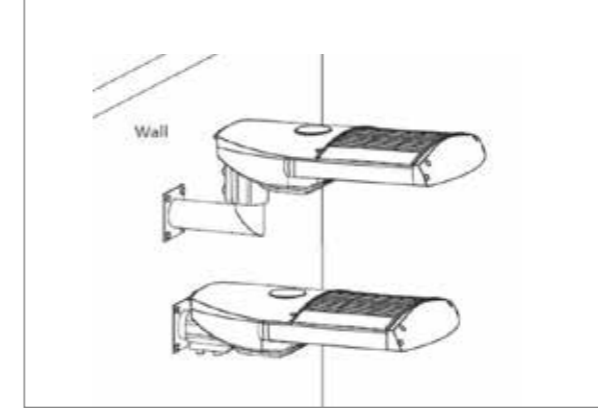
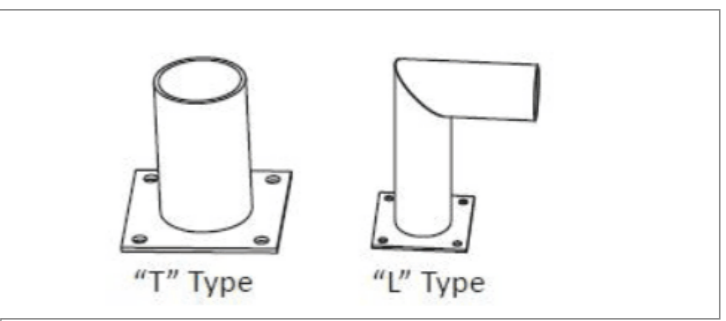
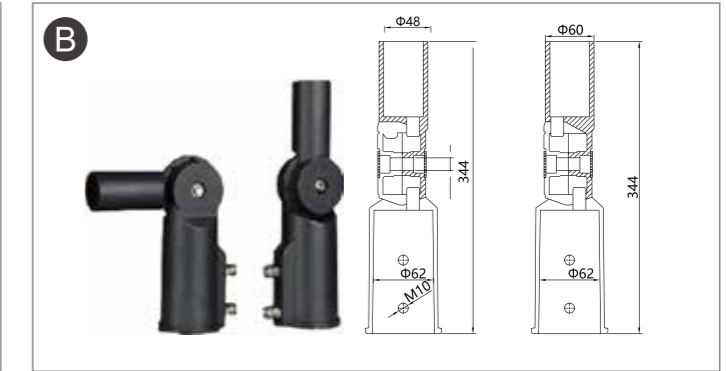

LED Flood Light

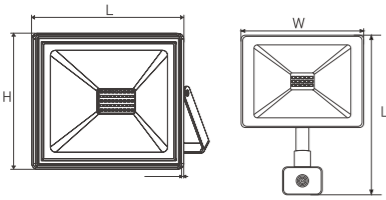

3000K 4000K 6500K

AC 100-265V ≥70 30.000h -20°+40° 15.000 90% IP 65 Energy saving CE

ITEM NO.	Wattage [W]	LED	Lumen [lm]	Beam angle	Power Factor	Material	Size [mm]
LED-YFLO-10W	10W	SMD2835	800	120°	>0.9	Aluminum	
LED-YFLO-20W	20W	SMD2835	1600	120°	>0.9	Aluminum	122*107*23
LED-YFLO-30W	30W	SMD2835	2400	120°	>0.9	Aluminum	144*125*26.3
LED-YFLO-50W	50W	SMD2835	4000	120°	>0.9	Aluminum	190*151,5*27
LED-YFLO-100W	100W	SMD2835	8000	120°	>0.9	Aluminum	256*208*30.5
LED-YFLO-150W	150W	SMD2835	12000	120°	>0.9	Aluminum	328*250*34
LED-YFLO-200W	200W	SMD2835	16000	120°	>0.9	Aluminum	388*275*38

LED Flood Light

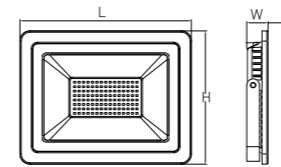
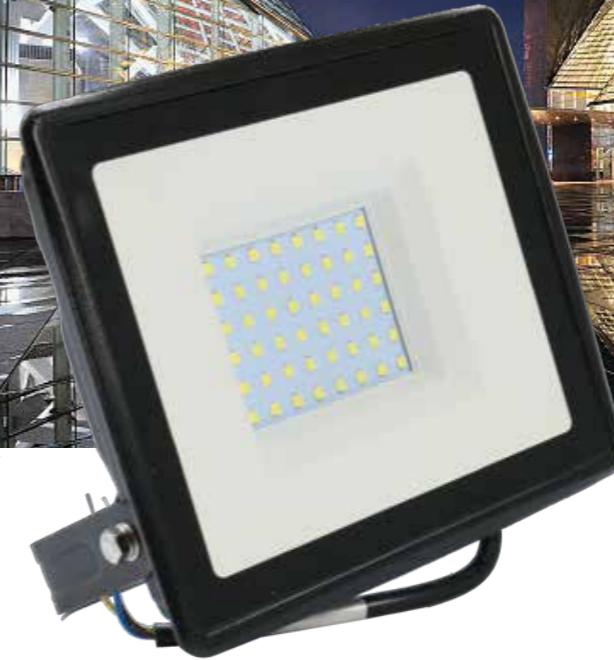
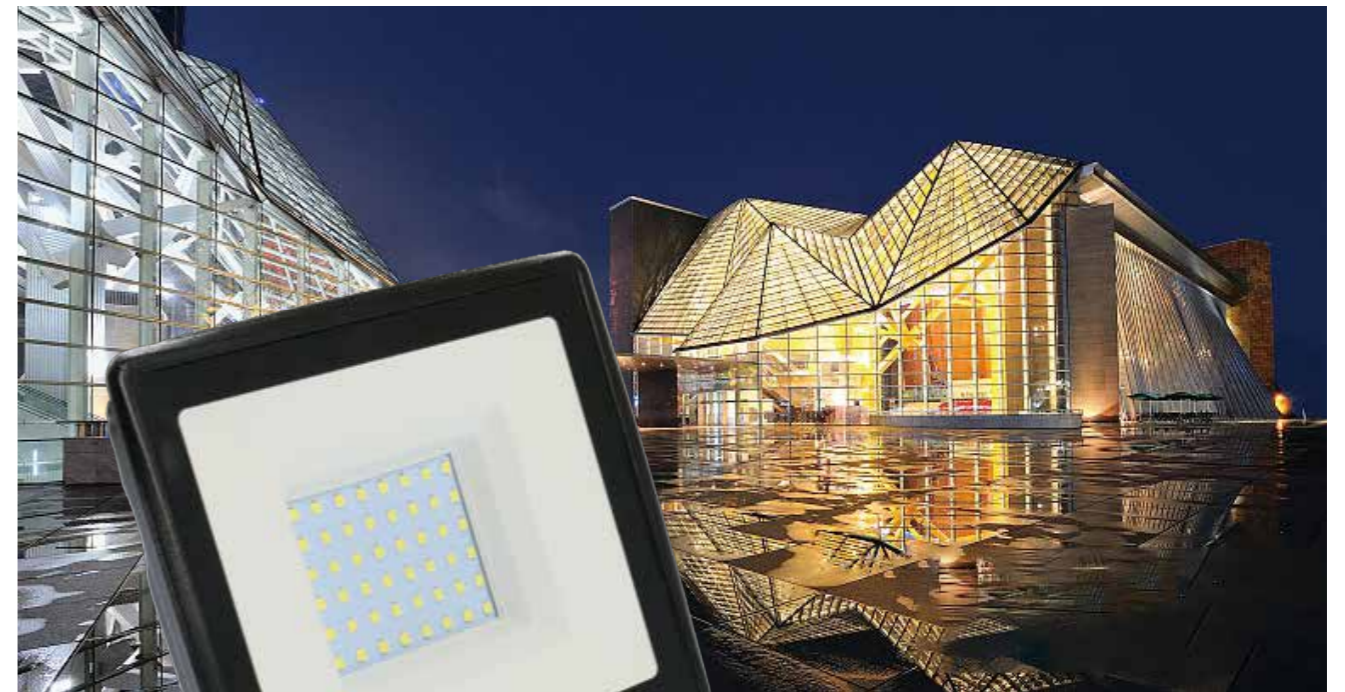

3000K 4000K 6500K

AC 220-240V ≥80 30.000h -20°+40° 15.000 90% IP 65 Energy saving CE

ITEM NO.	Wattage [W]	LED	Lumen [lm]	Beam angle	Power Factor	Material	Size [mm]
LED-YFLQ-10W	10W	SMD2835	900	120°	>0.9	Aluminum	78*51*15,6
LED-YFLQ-20W	20W	SMD2835	1800	120°	>0.9	Aluminum	103*99*23,5
LED-YFLQ-30W	30W	SMD2835	2700	120°	>0.9	Aluminum	125*119*25
LED-YFLQ-50W	50W	SMD2835	4500	120°	>0.9	Aluminum	165*160*35
LED-YFLQ-100W	100W	SMD2835	9000	120°	>0.9	Aluminum	215*198*38,5
LED-YFLQ-150W	150W	SMD2835	13500	120°	>0.9	Aluminum	280*253*41
LED-YFLQ-200W	200W	SMD2835	18000	120°	>0.9	Aluminum	350*318*43

LED Flood Light



3000K 4000K 6500K

AC 85-265V ≥70 30.000h -20°+40° 15.000 90% IP 65

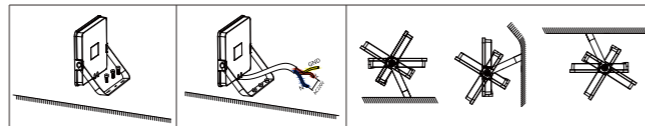

ITEM NO.	Wattage [W]	LED	Lumen [lm]	Beam angle	Power Factor	Material	Size [mm]
LED-YFLN-10W	10W	SMD2835	800	120°	>0.9	Aluminum	122*115.5*45
LED-YFLN-20W	20W	SMD2835	1600	120°	>0.9	Aluminum	139*127*45
LED-YFLN-30W	30W	SMD2835	2400	120°	>0.9	Aluminum	177*156*45
LED-YFLN-50W	50W	SMD2835	4000	120°	>0.9	Aluminum	203*184*45

LED Flood Light

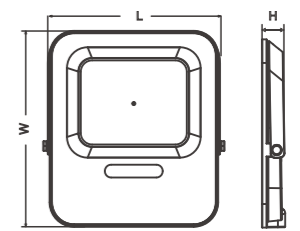

3000K 4000K 6500K

AC 180-265V ≥80 30.000h -20°+40° 15.000 90%

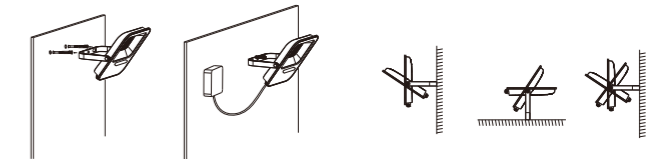

Item No.	Wattage [W]	LED	Lumen [lm]	Beam angle	Power Factor	Material	Size [mm]
LED-FLJ-20W	20W	SMD2835	1800	90°	>0.9	Aluminum+Glass	120.4*108.3*26.4
LED-FLJ-30W	30W	SMD2835	2700	90°	>0.9	Aluminum+Glass	141*158.6*30.2
LED-FLJ-50W	50W	SMD2835	4500	90°	>0.9	Aluminum+Glass	170.6*193.8*30.3
LED-FLJ-100W	100W	SMD2835	9000	90°	>0.9	Aluminum+Glass	206.4*234*32.4
LED-FLJ-150W	150W	SMD2835	13500	90°	>0.9	Aluminum+Glass	236.5*269*32.2
LED-FLJ-200W	200W	SMD2835	18000	90°	>0.9	Aluminum+Glass	272.5*309.3*32.5

LED Flood Light

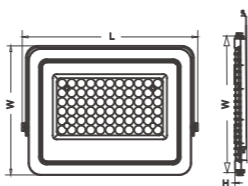
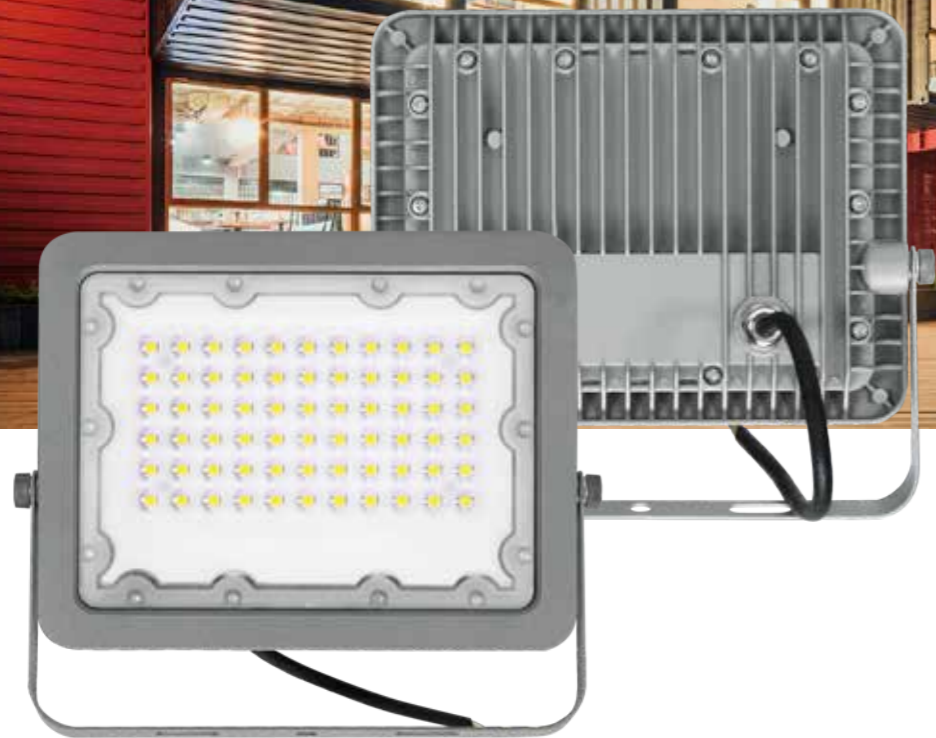

3000K 4000K 6500K

AC 180-265V ≥80 30.000h -20°+40° 15.000 90% Energy saving CE

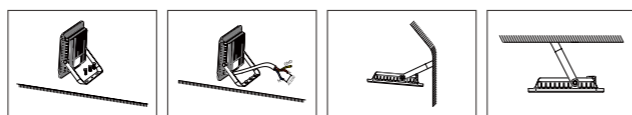

Item No.	Wattage [W]	LED	Lumen [lm]	Beam angle	Power Factor	Material	Size [mm]
LED-FLF-10W	10W	SMD2835	800	90°	>0.9	Aluminum+PC	95*84*15.5
LED-FLF-20W	20W	SMD2835	1600	90°	>0.9	Aluminum+PC	127*103*18.5
LED-FLF-30W	30W	SMD2835	2400	90°	>0.9	Aluminum+PC	167*127.6*18.5
LED-FLF-50W	50W	SMD2835	4000	90°	>0.9	Aluminum+PC	213*163.6*18.5
LED-FLF-100W	100W	SMD2835	8000	90°	>0.9	Aluminum+PC	277*214*18.5
LED-FLF-150W	150W	SMD2835	12000	90°	>0.9	Aluminum+PC	337*230*25.8
LED-FLF-200W	200W	SMD2835	16000	90°	>0.9	Aluminum+PC	393*280*38

LED Flood Light

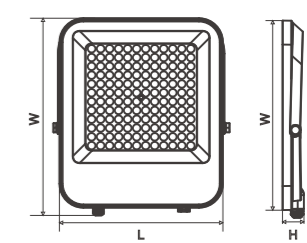

3000K 4000K 6500K

AC 180-265V ≥80 30.000h -20°+40° 15.000 90% Energy saving CE

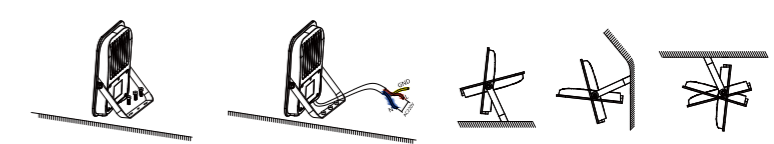

Item No.	Wattage [W]	LED	Lumen [lm]	Beam angle	Power Factor	Material	Size [mm]
LED-FLG-30W	30W	SMD2835	3600	90°	>0.9	Aluminum+PC	160.6*186*29
LED-FLG-50W	50W	SMD2835	6000	90°	>0.9	Aluminum+PC	187*217*29
LED-FLG-100W	100W	SMD2835	12000	90°	>0.9	Aluminum+PC	235.7*273*31
LED-FLG-150W	150W	SMD2835	18000	90°	>0.9	Aluminum+PC	254*299*32
LED-FLG-200W	200W	SMD2835	24000	90°	>0.9	Aluminum+PC	279.5*328*32

LED Flood Light



With sensor

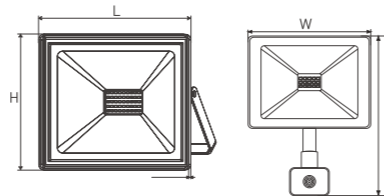
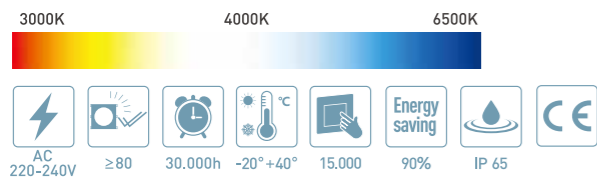

ITEM NO.	Wattage [W]	LED	Lumen [lm]	Beam angle	Power Factor	Material	Size [mm]
LED-FLP-10W	10W	SMD2835	800	120°	>0.9	Aluminum	90*70*25
LED-FLP-20W	20W	SMD2835	1600	120°	>0.9	Aluminum	118*90*25
LED-FLP-30W	30W	SMD2835	2400	120°	>0.9	Aluminum	148*120*28
LED-FLP-50W	50W	SMD2835	4000	120°	>0.9	Aluminum	178*150*28
LED-FLP-100W	100W	SMD2835	8000	120°	>0.9	Aluminum	250*215*30
LED-FLP-150W	150W	SMD2835	12000	120°	>0.9	Aluminum	320*230*35
LED-FLP-200W	200W	SMD2835	16000	120°	>0.9	Aluminum	380*265*35
LED-FLP-300W	300W	SMD2835	24000	120°	>0.9	Aluminum	480*310*60
LED-FLP-400W	400W	SMD2835	32000	120°	>0.9	Aluminum	500*375*60
LED-FLP-500W	500W	SMD2835	40000	120°	>0.9	Aluminum	605*475*77

LED Flood Light

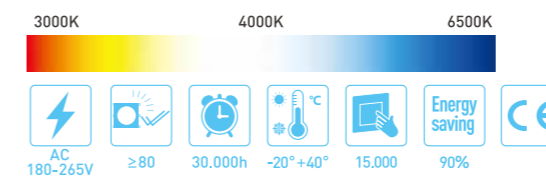

Item No.	Wattage [W]	LED	Lumen [lm]	Beam angle	Power Factor	Material	Size [mm]
LED-FLE-250W	250W	SMD2835	30000	110°	>0.9	Aluminum	439*346*56
LED-FLE-300W	300W	SMD2835	36000	110°	>0.9	Aluminum	529*415*55
LED-FLE-400W	400W	SMD2835	48000	110°	>0.9	Aluminum	580*460*155
LED-FLE-500W	500W	SMD2835	60000	110°	>0.9	Aluminum	580*460*155
LED-FLE-800W	800W	SMD2835	96000	110°	>0.9	Aluminum	709*709*155
LED-FLE-1000W	1000W	SMD2835	120000	110°	>0.9	Aluminum	709*709*155

LED Flood Light

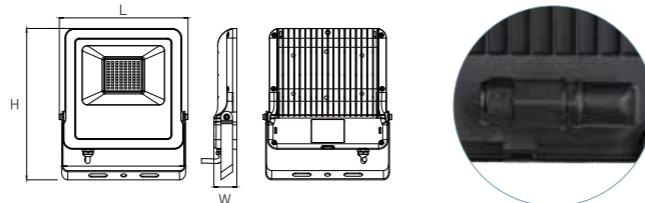
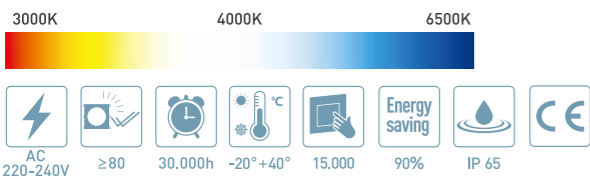

ITEM NO.	Wattage [W]	LED	Lumen [lm]	Beam angle	Power Factor	Material	Size [mm]
LED-FLC-10W	10W	SMD2835	800	120°	>0.5	Aluminum	133*95*37
LED-FLC-20W	20W	SMD2835	1600	120°	>0.5	Aluminum	160*115*40
LED-FLC-30W	30W	SMD2835	2400	120°	>0.9	Aluminum	208*147*40
LED-FLC-50W	50W	SMD2835	4000	120°	>0.9	Aluminum	235*173*44
LED-FLC-100W	100W	SMD2835	8000	120°	>0.9	Aluminum	316*225*52

LED Flood Light

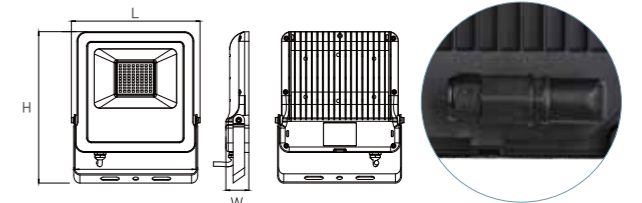
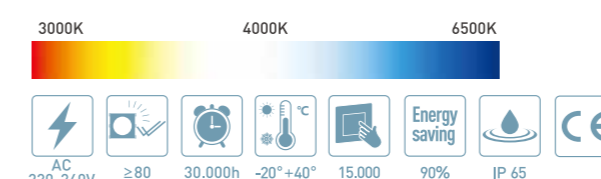

ITEM NO.	Wattage [W]	LED	Lumen [lm]	Beam angle	Power Factor	Material	Size [mm]
LED-FLC-30W(Microwave)	30W	SMD2835	2400	120°	>0.9	Aluminum	208*147*40
LED-FLC-50W(Microwave)	50W	SMD2835	4000	120°	>0.9	Aluminum	235*173*44
LED-FLC-30W(RGB)	30W	SMD2835	RGB	120°	>0.9	Aluminum	208*147*40
LED-FLC-50W(RGB)	50W	SMD2835	RGB	120°	>0.9	Aluminum	235*173*44

LED Flood Light

LED Flood Light

LED-FLC(Blue tooth/Wifi)



PIR Sensor(B)

PIR Sensor(C)



LED-FLCM(Blue tooth/Wifi)

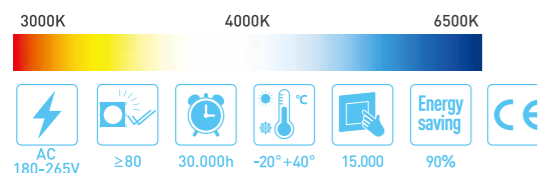

Item No.	Wattage [W]	LED	Lumen [lm]	Beam angle	Power Factor	Material	Size [mm]
LED-FLC-14W(Blue tooth/Wifi)	14W	SMD2835	RGB+CCT	120°	>0.7	Aluminum+Glass	160*115*40
LED-FLC-24W(Blue tooth/Wifi)	24W	SMD2835	RGB+CCT	120°	>0.7	Aluminum+Glass	208*147*40
LED-FLC-45W(Blue tooth/Wifi)	45W	SMD2835	RGB+CCT	120°	>0.9	Aluminum+Glass	235*173*44
LED-FLCM-14W(Blue tooth/Wifi)	14W	SMD2835	RGB+CCT	120°	>0.7	Aluminum+PC	160*115*40
LED-FLCM-24W(Blue tooth/Wifi)	24W	SMD2835	RGB+CCT	120°	>0.7	Aluminum+PC	208*147*40
LED-FLCM-45W(Blue tooth/Wifi)	45W	SMD2835	RGB+CCT	120°	>0.9	Aluminum+PC	235*173*44

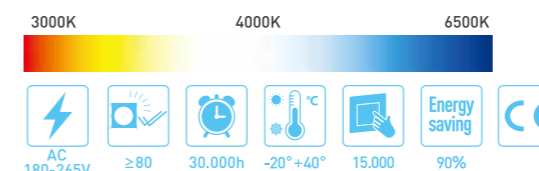

Item No.	Wattage [W]	LED	Lumen [lm]	Beam angle	Power Factor	Material	Size [mm]
LED-FLCM-10W(A/B/C)	10W	SMD2835	750	120°	>0.9	Aluminum+PC	131*87*40
LED-FLCM-20W(A/B/C)	20W	SMD2835	1500	120°	>0.9	Aluminum+PC	157*111*44
LED-FLCM-30W(A/B/C)	30W	SMD2835	2250	120°	>0.9	Aluminum+PC	205*142*49
LED-FLCM-50W(A/B/C)	50W	SMD2835	3750	120°	>0.9	Aluminum+PC	235*170*53

LED Flood Light



With sensor

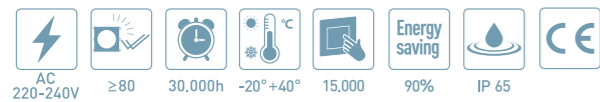
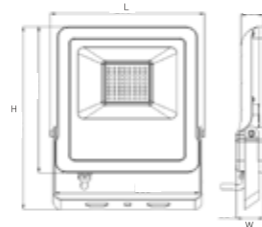
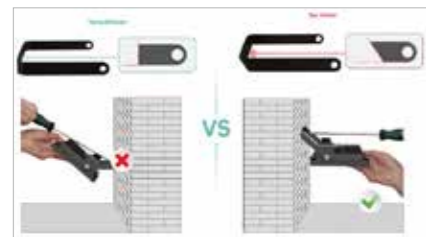

ITEM NO.	Wattage [W]	LED	Lumen [lm]	Beam angle	Power Factor	Material	Size [mm]
LED-FLT-10W	10W	SMD2835	800	120°	>0.9	Aluminum	125*104*27
LED-FLT-20W	20W	SMD2835	1600	120°	>0.9	Aluminum	152*125*28
LED-FLT-30W	30W	SMD2835	2400	120°	>0.9	Aluminum	168*209*27
LED-FLT-50W	50W	SMD2835	4000	120°	>0.9	Aluminum	200*237*36

LED Flood Light

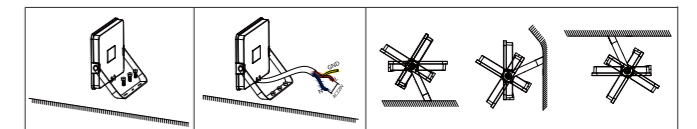
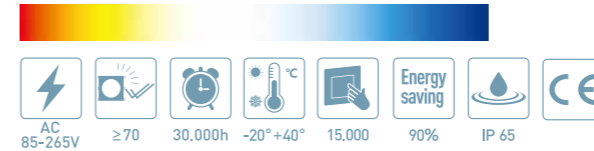
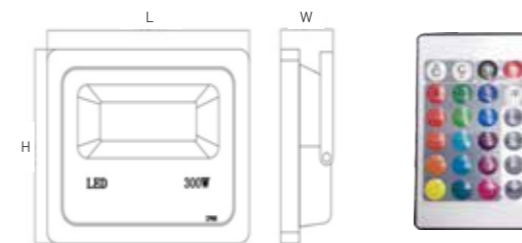

ITEM NO.	Wattage [W]	LED	Lumen [lm]	Beam angle	Power Factor	Material	Size [mm]
LED-FLH-10W	10W	SMD2835	800	120°	>0.5	Aluminum	110*100*32
LED-FLH-20W	20W	SMD2835	1600	120°	>0.5	Aluminum	130*115*32
LED-FLH-30W	30W	SMD2835	2400	120°	>0.5	Aluminum	170*150*35
LED-FLH-50W	50W	SMD2835	4000	120°	>0.9	Aluminum	240*210*44
LED-FLH-100W	100W	SMD2835	8000	120°	>0.9	Aluminum	270*260*45
LED-FLH-150W	150W	SMD2835	12000	120°	>0.9	Aluminum	310*280*55
LED-FLH-200W	200W	SMD2835	16000	120°	>0.9	Aluminum	345*330*55

LED Flood Light

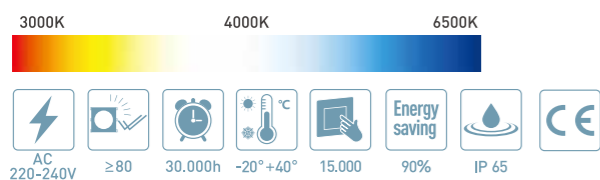

ITEM NO.	Wattage [W]	LED	Lumen [lm]	Beam angle	Power Factor	Material	Size [mm]
LED-FLK-30W	30W	SMD2835	2400	120°	>0.9	Aluminum	135*106*23
LED-FLK-50W	50W	SMD2835	4000	120°	>0.9	Aluminum	196*141*28
LED-FLK-70W	70W	SMD2835	5600	120°	>0.9	Aluminum	211*152*28
LED-FLK-100W	100W	SMD2835	8000	120°	>0.9	Aluminum	271*201*32
LED-FLK-150W	150W	SMD2835	12000	120°	>0.9	Aluminum	310*235*35
LED-FLK-200W	200W	SMD2835	16000	120°	>0.9	Aluminum	372*282*41

LED Flood Light

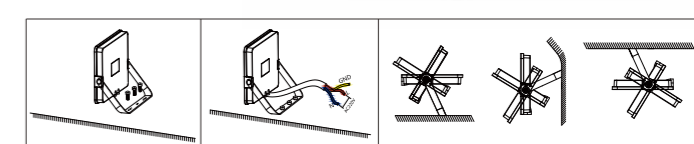
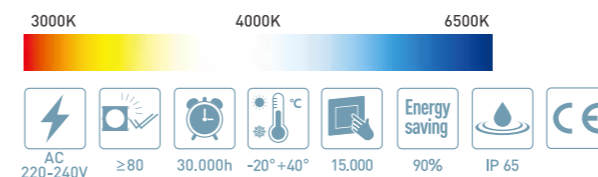

ITEM NO.	Wattage [W]	Beam angle	Power Factor	Color Temperature	Material	Size [mm]
LED-FLK-20W(RGB)	20W	120°	>0.9	RGB	Aluminum	135*106*23
LED-FLK-30W(RGB)	30W	120°	>0.9	RGB	Aluminum	135*106*23
LED-FLK-50W(RGB)	50W	120°	>0.9	RGB	Aluminum	196*141*28
LED-FLK-70W(RGB)	70W	120°	>0.9	RGB	Aluminum	211*152*28
LED-FLK-100W(RGB)	100W	120°	>0.9	RGB	Aluminum	271*201*32
LED-FLK-150W(RGB)	150W	120°	>0.9	RGB	Aluminum	310*235*35
LED-FLK-200W(RGB)	200W	120°	>0.9	RGB	Aluminum	372*282*41

LED Flood Light

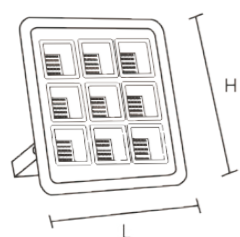

3000K 4000K 6500K



ITEM NO.	Wattage [W]	LED	Lumen [lm]	Power Factor	Beam angle	Material	Size [mm]
LED-FLM-50W	50W	SMD2835	4000	>0.9	90°	Aluminum	229*68*243
LED-FLM-100W	100W	SMD2835	8000	>0.9	90°	Aluminum	279*75*290
LED-FLM-200W	200W	SMD2835	16000	>0.9	90°	Aluminum	320*76*366
LED-FLM-300W	300W	SMD2835	24000	>0.9	90°	Aluminum	369*80*435
LED-FLM-400W	400W	SMD2835	32000	>0.9	90°	Aluminum	439*99*523
LED-FLM-500W	500W	SMD2835	40000	>0.9	90°	Aluminum	439*99*523

LED Flood Light

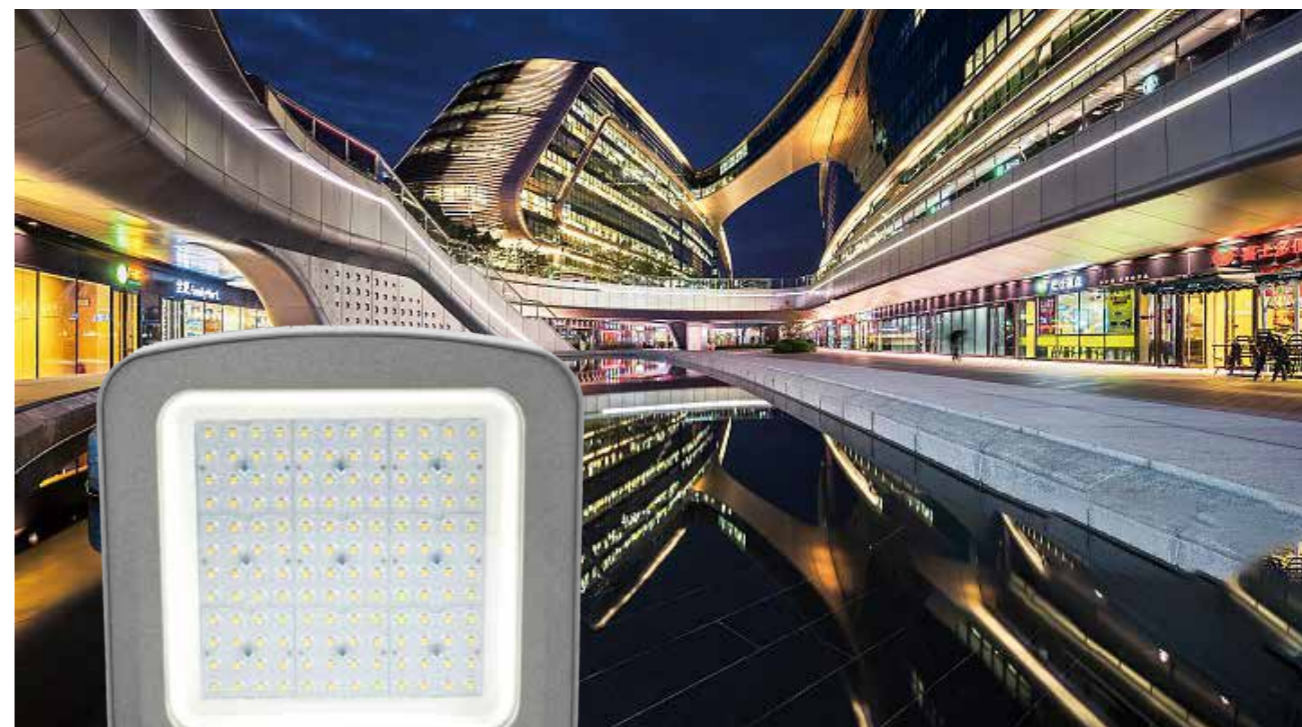

3000K 4000K 6500K



ITEM NO.	Wattage [W]	LED	Lumen [lm]	Power Factor	Beam angle	Material	Size [mm]
LED-FLH-50W	50W	SMD3030	6000	>0.9	120°	Aluminum	320*224*50
LED-FLH-100W	100W	SMD3030	12000	>0.9	120°	Aluminum	422*291*62
LED-FLH-200W	200W	SMD3030	24000	>0.9	120°	Aluminum	520*342*65
LED-FLH-300W	300W	SMD3030	36000	>0.9	120°	Aluminum	620*450*84

LED Work Light



3000K 4000K 6500K

AC 180-265V
 ≥80
 30,000h
 -20°+40°
 15,000
 90%
 CE

Item No.	Wattage [W]	LED	Lithium battery	Discharge time	Beam angle	Material	Size [mm]
LED-WLF-30W	30W	SMD2835	3.2V/6AH	4-12hours	90°	Aluminum+PC	115*115*250
LED-WLF-50W	50W	SMD2835	3.2V/12AH	4-12hours	90°	Aluminum+PC	115*115*250
LED-WLF-100W	100W	SMD2835	3.7V/18AH	4-12hours	90°	Aluminum+PC	115*115*250

LED Work Light



LED-WLC



LED-WLB



LED-WLA

3000K 4000K 6500K

≥70
 30,000h
 -20°+40°
 15,000
 90%
 IP 54
 CE

ITEM NO.	Wattage [W]	LED	Battery Type	Discharge time [Hours]	Beam angle	Material	Size [mm]
LED-WLA-10W	10W	COB	Lithium (3.7V/4.4AH)	3-9	120°	Plastic	242*215*25
LED-WLB-10W	10W	SMD2835	Lithium (7.4V/2.2AH)	3-6	120°	Aluminum	242*215*25
LED-WLB-20W	20W	SMD2835	Lithium (7.4V/4.4AH)	3-6	120°	Aluminum	290*258*30
LED-WLC-10W	10W	SMD2835	Lithium (3.7V/4.4AH)	3-6	120°	Aluminum	298*246*32
LED-WLC-20W	20W	SMD2835	Lithium (3.7V/8.8AH)	3-6	120°	Aluminum	298*246*32

LED Work Light



3000K 4000K 6500K

≥70
 30.000h
 -20°+40°
 15.000
 Energy saving 90%
 IP 44
 CE



ITEM NO.	Wattage [W]	LED	Battery Type	Discharge time [Hours]	Beam angle	Material	Size [mm]
LED-WL-10W	10W	COB	Lithium(1*18650)	4-5	120°	Aluminum	115*115*250
LED-WL-20W	20W	COB	Lithium(2*18650)	4-5	120°	Aluminum	159*159*300
LED-WL-30W	30W	COB	Lithium(4*18650)	4-5	120°	Aluminum	225*225*380
LED-WL-50W	50W	COB	Lithium(8*18650)	4-5	120°	Aluminum	225*225*380
LED-WL-10W(X)	10W	COB	Lithium(2*18650)	3-13	120°	Aluminum	130*160*248
LED-WL-20W(X)	20W	COB	Lithium(4*18650)	3-13	120°	Aluminum	195*180*290

LED Work Light



3000K 4000K 6500K

≥70
 30.000h
 -20°+40°
 15.000
 Energy saving 90%
 IP 44
 CE



ITEM NO.	Wattage [W]	LED	Battery Type	Discharge time [Hours]	Beam angle	Material	Size [mm]
LED-WL-10W	10W	COB	Lithium(1*18650)	4-5	120°	Aluminum	115*115*250
LED-WL-20W	20W	COB	Lithium(2*18650)	4-5	120°	Aluminum	159*159*300
LED-WL-30W	30W	COB	Lithium(4*18650)	4-5	120°	Aluminum	225*225*380
LED-WL-50W	50W	COB	Lithium(8*18650)	4-5	120°	Aluminum	225*225*380
LED-WL-10W(X)	10W	COB	Lithium(2*18650)	3-13	120°	Aluminum	130*160*248
LED-WL-20W(X)	20W	COB	Lithium(4*18650)	3-13	120°	Aluminum	195*180*290

LED Work Light

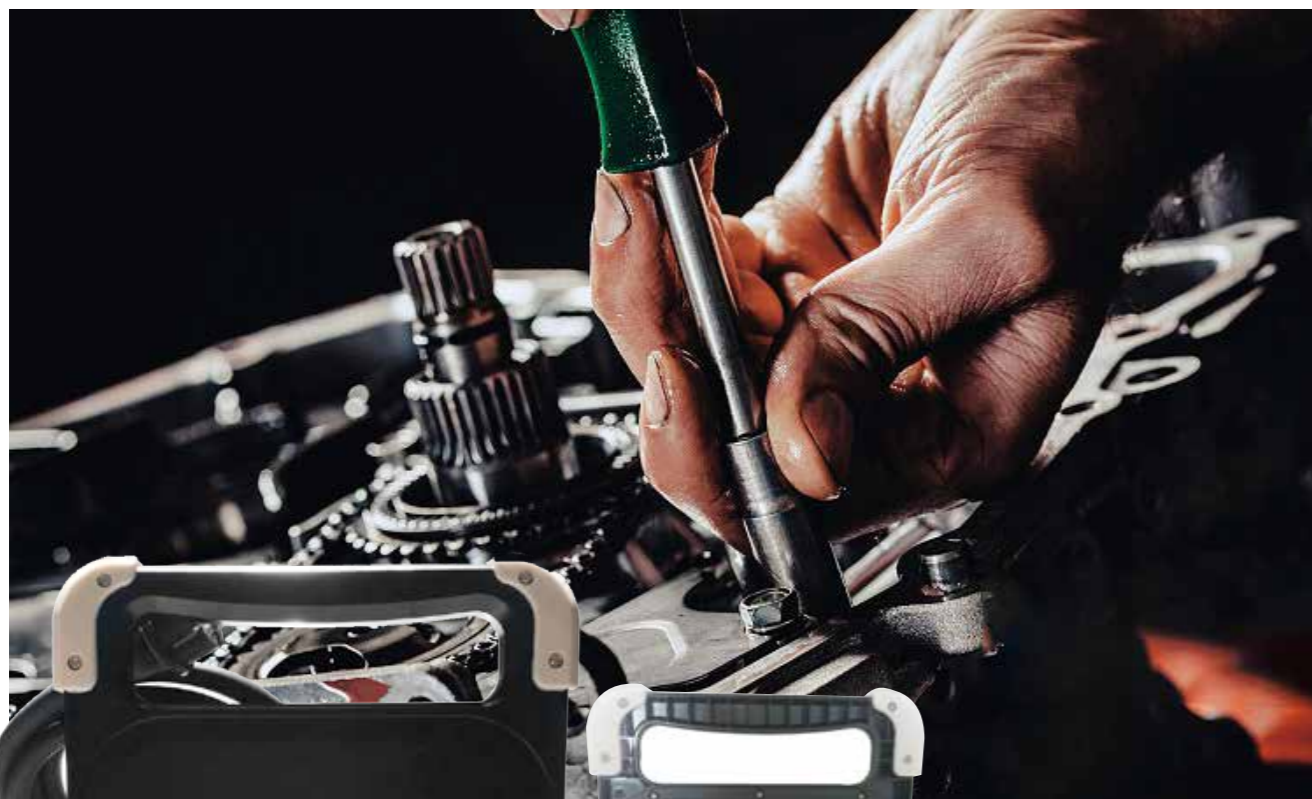

3000K 4000K 6500K



ITEM NO.	Wattage [W]	LED	Lumen [lm]	Beam angle	Power Factor	Material	Size [mm]
LED-WLE-20W	20W	SMD2835	1900	130°	>0.9	Aluminum+Plastic	175*70*220
LED-WLE-30W	30W	SMD2835	3200	130°	>0.9	Aluminum+Plastic	215*72*272
LED-WLE-50W	50W	SMD2835	5200	130°	>0.9	Aluminum+Plastic	250*72*320

LED Work Light



3000K 4000K 6500K



ITEM NO.	Wattage [W]	LED	Lumen [lm]	Beam angle	Power Factor	Material	Size [mm]
LED-WLG-30W	30W	SMD2835	2100	130°	>0.9	PC+PET	240*95*300
LED-WLG-50W	50W	SMD2835	3500	130°	>0.9	PC+PET	275*130*390

LED Work Light

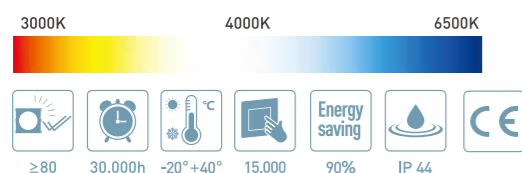

ITEM NO.	Wattage [W]	LED	Lumen [lm]	Work time(h)	Beam angle	Material	Size [mm]
LED-WLK-10W	10W	SMD2835	400/800	4,5/2,5	120°	Aluminum	215*215*230
LED-WLK-20W	20W	SMD2835	400/800/1600	8/4/2	120°	Aluminum	215*215*230

LED Work Light

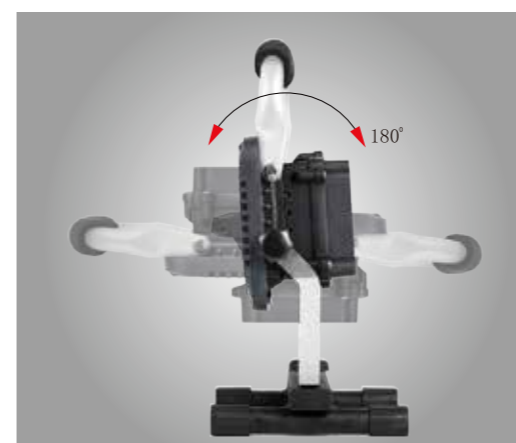

USB OUTPUT 5V 1A

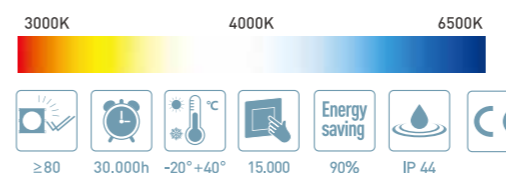

ITEM NO.	Wattage [W]	LED	Lumen [lm]	Work time(h)	Beam angle	Material	Size [mm]
LED-WLM-20W	20W	SMD2835	800/1800	5/3	120°	Aluminum	205*160*300
LED-WLM-30W	30W	SMD2835	500/1200/2700	10/4/2,5	120°	Aluminum	205*160*300

LED Work Light

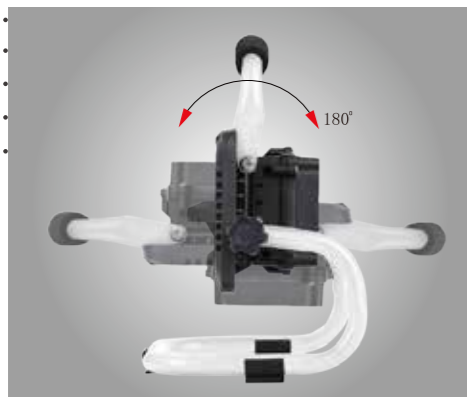

USB OUTPUT 5V 1A

Free installation, Quickly use



ITEM NO.	Wattage [W]	LED	Lumen [lm]	Work time(h)	Beam angle	Material	Size [mm]
LED-WLN-20W	20W	SMD2835	800/1800	5/3	120°	Aluminum	225*170*270
LED-WLN-30W	30W	SMD2835	500/1200/2700	10/4/2.5	120°	Aluminum	225*170*270

LED Work Light



ITEM NO.	Wattage [W]	LED	Lumen [lm]	Beam angle	Power Factor	Material	Size [mm]
LED-WLO-30W	30W	SMD2835	2400	120°	>0,9	Aluminum	230*175*260
LED-WLO-50W	50W	SMD2835	4000	120°	>0,9	Aluminum	270*195*300

LED Work Light

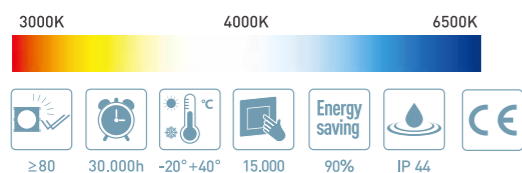
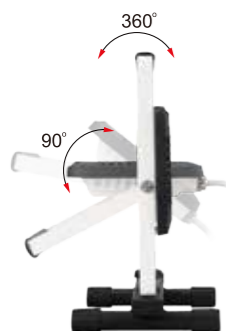

ITEM NO.	Wattage [W]	LED	Lumen [lm]	Beam angle	Power Factor	Material	Size [mm]
LED-WLP-30W	30W	SMD2835	2400	120°	>0.9	Aluminum	230*175*260
LED-WLP-50W	50W	SMD2835	4000	120°	>0.9	Aluminum	270*195*300
LED-WLP-100W	100W	SMD2835	8000	120°	>0.9	Aluminum	290*185*385

LED Work Light

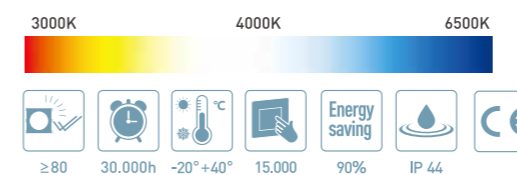
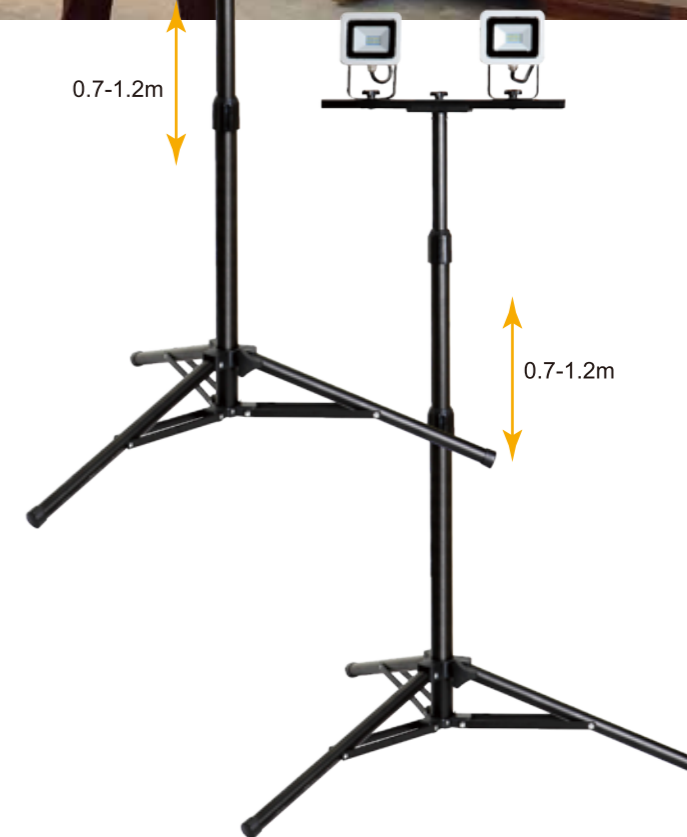

ITEM NO.	Wattage [W]	LED	Lumen [lm]	Beam angle	Power Factor	Material	Size [mm]
LED-WLQ-2*30W	60W	SMD2835	2*2400	120°	>0.9	Aluminum	760*760*1900
LED-WLQ-2*50W	100W	SMD2835	2*4000	120°	>0.9	Aluminum	760*760*1900
LED-WLQ-2*100W	200W	SMD2835	2*8000	120°	>0.9	Aluminum	760*760*1900

LED Work Light

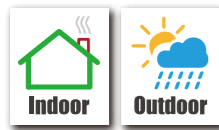

2400
LUMEN

4000
LUMEN

8000
LUMEN



ITEM NO.	Wattage [W]	LED	Lumen [lm]	Beam angle	Power Factor	Material	Size [mm]
LED-WLR-30W	30W	SMD2835	2400	120°	>0.9	Aluminum	760*760*1900
LED-WLR-50W	50W	SMD2835	4000	120°	>0.9	Aluminum	760*760*1900
LED-WLR-100W	100W	SMD2835	8000	120°	>0.9	Aluminum	760*760*1900

LED Work Light

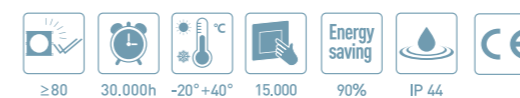

ITEM NO.	Wattage [W]	LED	Lumen [lm]	Beam angle	Power Factor	Material	Size [mm]
LED-WLP-30W	30W	SMD2835	2400	360°		Aluminum	770*740*1070
LED-WLP-50W	50W	SMD2835	3800	360°	>0.9	Aluminum	770*740*1070
LED-WLP-100W	100W	SMD2835	7500	360°	>0.9	Aluminum	770*740*1500

LED Highbay Light



3000K 4000K 6500K

ITEM NO.	Wattage [W]	LED	Lumen [lm]	Beam angle	Power Factor	Material	Size [mm]
LED-YHLD-100W	100W	SMD2835	10000	110°	>0.9	Aluminum	D235*H85
LED-YHLD-150W	150W	SMD2835	15000	110°	>0.9	Aluminum	D286*H85
LED-YHLD-200W	200W	SMD2835	20000	110°	>0.9	Aluminum	D315*H85

LED Highbay Light



3000K 4000K 6500K

ITEM NO.	Wattage [W]	LED	Lumen [lm]	Beam angle	Power Factor	Material	Size [mm]
LED-YHLN-100W	100W	SMD2835	10000	90°	>0.9	Aluminum	D271*H90
LED-YHLN-150W	150W	SMD2835	15000	90°	>0.9	Aluminum	D310*H90
LED-YHLN-200W	200W	SMD2835	20000	90°	>0.9	Aluminum	D380*H90

LED Highbay Light



3000K 4000K 6500K

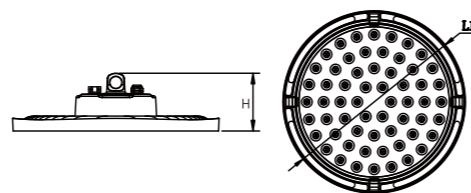

ITEM NO.	Wattage [W]	LED	Lumen [lm]	Beam angle	Power Factor	Material	Size [mm]
LED-HLA-100W	100W	SMD2835	10000	110°	>0.9	Aluminum	D230*H88
LED-HLA-150W	150W	SMD2835	15000	110°	>0.9	Aluminum	D260*H88
LED-HLA-200W	200W	SMD2835	20000	110°	>0.9	Aluminum	D310*H88

LED Highbay Light

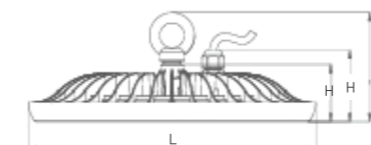

3000K 4000K 6500K



ITEM NO.	Wattage [W]	LED	Lumen [lm]	Beam angle	Power Factor	Material	Size [mm]
LED-HLC-100W	100W	SMD2835	9000	90°/120°	>0.9	Aluminum	D280*H106
LED-HLC-150W	150W	SMD2835	13500	90°/120°	>0.9	Aluminum	D340*H106
LED-HLC-200W	200W	SMD2835	18000	90°/120°	>0.9	Aluminum	D400*H121

LED Highbay Light



ITEM NO.	Wattage [W]	LED	Lumen [lm]	Beam angle	Power Factor	Material	Size [mm]
LED-HLB-100W	100W	SMD2835	10000	60°/90°/120°	>0.9	Aluminum	D259.5*H50
LED-HLB-150W	150W	SMD2835	15000	60°/90°/120°	>0.9	Aluminum	D310*H50
LED-HLB-200W	200W	SMD2835	20000	60°/90°/120°	>0.9	Aluminum	D359.5*H52

LED Highbay Light



ITEM NO.	Wattage [W]	LED	Lumen [lm]	Beam angle	Power Factor	Material	Size [mm]
LED-HLF-100W	100W	SMD2835	10000	90°	>0.9	Aluminum	D230*H160
LED-HLF-150W	150W	SMD2835	15000	90°	>0.9	Aluminum	D310*H176
LED-HLF-200W	200W	SMD2835	20000	90°	>0.9	Aluminum	D360*H248

LED Highbay Light



ITEM NO.	Wattage [W]	LED	Lumen [lm]	Beam angle	Power Factor	Material	Size [mm]
LED-HLE-100W	100W	SMD2835	10000	60°/90°/120°	>0.9	Aluminum	D280*H170
LED-HLE-150W	150W	SMD2835	15000	60°/90°/120°	>0.9	Aluminum	D350*H185
LED-HLE-200W	200W	SMD2835	20000	60°/90°/120°	>0.9	Aluminum	D400*H200

LED Highbay Light

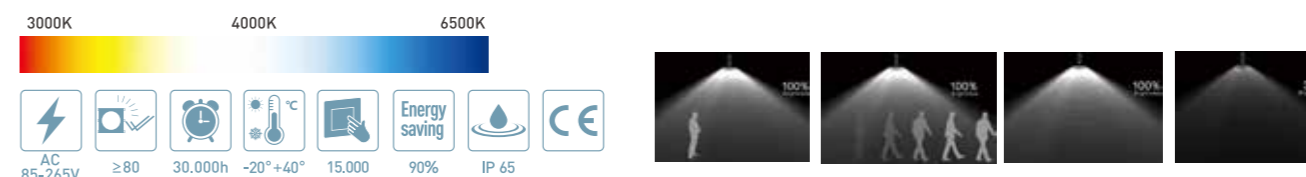
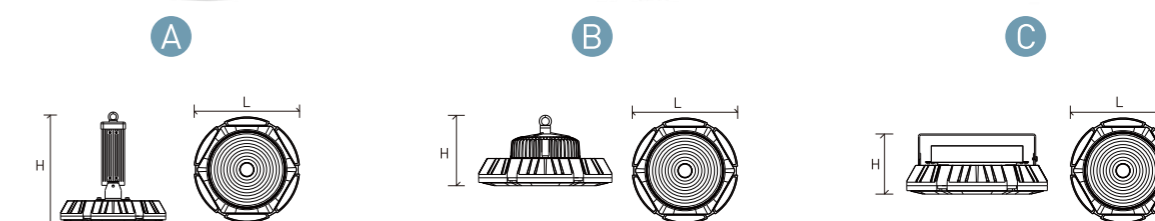

ITEM NO.	Wattage [W]	LED	Lumen [lm]	Beam angle	Power Factor	Material	Size [mm]
LED-HLG-100W(A/B/C)	100W	SMD3030	15000	60°/90°/120°	>0.9	Aluminum	D300*H310
LED-HLG-150W(A/B/C)	150W	SMD3030	22500	60°/90°/120°	>0.9	Aluminum	D300*H310
LED-HLG-185W(A/B/C)	185W	SMD3030	27750	60°/90°/120°	>0.9	Aluminum	D300*H310

LED Highbay Light



3000K 4000K 6500K

ITEM NO.	Wattage [W]	LED	Lumen [lm]	Beam angle	Power Factor	Material	Size [mm]
LED-YHLL-100W	100W	SMD2835	14000	90°	>0.9	Aluminum	D290*H133.8
LED-YHLL-150W	150W	SMD2835	21000	90°	>0.9	Aluminum	D332.7*H142
LED-YHLL-200W	200W	SMD2835	28000	90°	>0.9	Aluminum	D377*H159
LED-YHLL-250W	250W	SMD2835	30000	90°	>0.9	Aluminum	D378*H140
LED-YHLL-300W	300W	SMD2835	36000	90°	>0.9	Aluminum	D378*H140
LED-YHLL-400W	400W	SMD2835	48000	90°	>0.9	Aluminum	D378*H140

LED Highbay Light



3000K 4000K 6500K

ITEM NO.	Wattage [W]	LED	Lumen [lm]	Beam angle	Power Factor	Material	Size [mm]
LED-YHLM-100W	100W	SMD2835	11000	120°	>0.9	Aluminum	D212*H101
LED-YHLM-150W	150W	SMD2835	16500	120°	>0.9	Aluminum	D245*H102
LED-YHLM-200W	200W	SMD2835	22000	120°	>0.9	Aluminum	D271*H107

LED Highbay Light



3000K 4000K 6500K

AC 220-240V ≥70 30,000h -20°+40° 15,000 90% IP 44

ITEM NO.	Wattage [W]	LED	Lumen [lm]	Beam angle	Power Factor	Material	Size [mm]
LED-HLH-100W	100W	SMD3030	9000	90°	>0.9	Aluminum	D450*H345
LED-HLH-150W	150W	SMD3030	13500	90°	>0.9	Aluminum	D450*H345
LED-HLH-200W	200W	SMD3030	18000	90°	>0.9	Aluminum	D450*H360
LED-HLJ-100W	100W	SMD3030	9000	120°	>0.9	Aluminum	D450*H345
LED-HLJ-150W	150W	SMD3030	13500	120°	>0.9	Aluminum	D450*H345
LED-HLJ-200W	200W	SMD3030	18000	120°	>0.9	Aluminum	D450*H360
LED-HLJ-300W	300W	SMD3030	27000	120°	>0.9	Aluminum	D500*H325

LED Highbay Light



3000K 4000K 6500K

AC 85-265V ≥70 30,000h -20°+40° 15,000 90% IP 44

ITEM NO.	Wattage [W]	LED	Lumen [lm]	Beam angle	Power Factor	Material	Size [mm]
LED-HLK-50W	50W	COB	5000	120°	>0.9	Aluminum	D358*H290
LED-HLK-100W	100W	COB	11000	120°	>0.9	Aluminum	D459*H389
LED-HLK-150W	150W	COB	16500	120°	>0.9	Aluminum	D670*H490
LED-HLK-200W	200W	COB	22000	120°	>0.9	Aluminum	D670*H490
LED-HLI-100W	100W	COB	8000	120°	>0.9	Aluminum	D410*H245
LED-HLI-150W	150W	COB	12000	120°	>0.9	Aluminum	D500*H350
LED-HLI-200W	200W	COB	16000	120°	>0.9	Aluminum	D500*H350
LED-HLI-300W	300W	COB	24000	120°	>0.9	Aluminum	D570*H385
LED-HLI-400W	400W	COB	32000	120°	>0.9	Aluminum	D570*H385

MODULARIZATION FLOOD LIGHT

Patent structure and appearance
Modular can be spliced and DIY appearance
IP67 Level protection
Luminaries lighting efficiency 130lm/w-160lm/e
Customize logo on fixtures

60~1000W

Beam Angle: 15°/30°/60°/90°/120° Optional

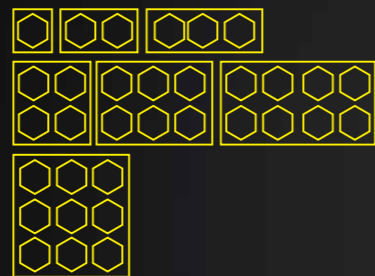

NEW

LED Stadium Light

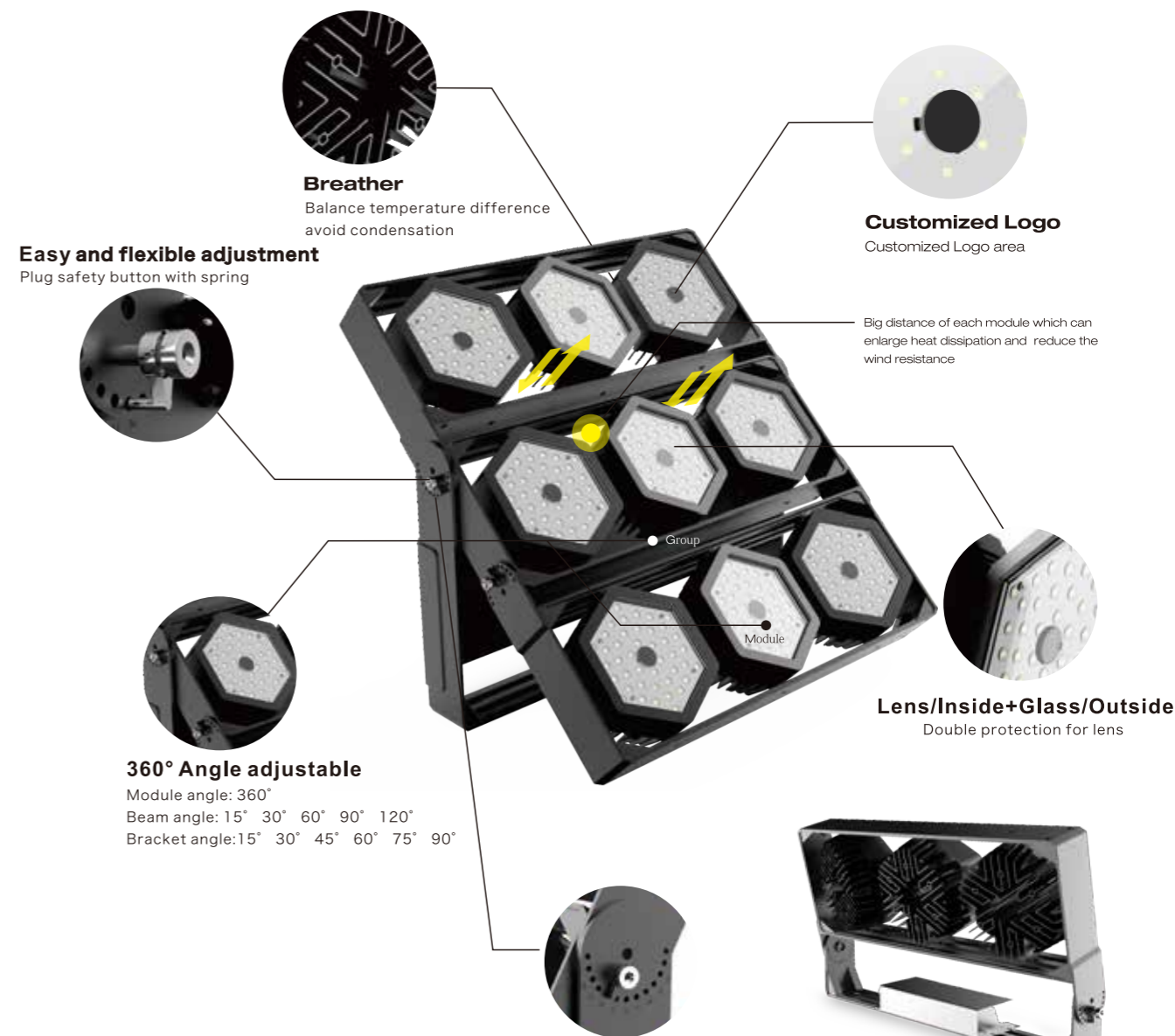

3000K 4000K 6500K

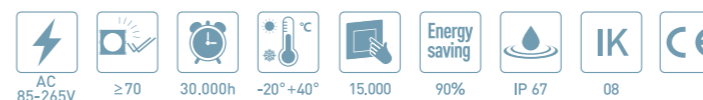

ITEM NO.	Wattage [W]	LED	Lumen [lm]	Beam angle	Material	Power Factor	Size [mm]
LED-TLD-100W	100W	SMD3030	14000	15°/30°/60°/90°/120°	Aluminum	>0.9	328*208*92
LED-TLD-200W	200W	SMD3030	28000	15°/30°/60°/90°/120°	Aluminum	>0.9	548*208*92
LED-TLD-300W	300W	SMD3030	42000	15°/30°/60°/90°/120°	Aluminum	>0.9	768*208*92
LED-TLD-400W	400W	SMD3030	56000	15°/30°/60°/90°/120°	Aluminum	>0.9	458*396*92
LED-TLD-600W	600W	SMD3030	84000	15°/30°/60°/90°/120°	Aluminum	>0.9	576*419*92
LED-TLD-800W	800W	SMD3030	112000	15°/30°/60°/90°/120°	Aluminum	>0.9	757*458*92
LED-TLD-900W	900W	SMD3030	126000	15°/30°/60°/90°/120°	Aluminum	>0.9	639*572*92
LED-TLD-1200W	1200W	SMD3030	168000	15°/30°/60°/90°/120°	Aluminum	>0.9	757*639*92

LED Stadium Light



3000K 4000K 6500K

ITEM NO.	Wattage [W]	LED	Lumen [lm]	Beam angle	Power Factor	Material	Size [mm]
LED-YTLH-50W	50W	SMD3030	5000	60°/90°	>0.9	Aluminum	345*75*180
LED-YTLH-100W	100W	SMD3030	10000	60°/90°	>0.9	Aluminum	345*155*180
LED-YTLH-200W	200W	SMD3030	20000	60°/90°	>0.9	Aluminum	345*315*180
LED-YTLH-300W	300W	SMD3030	30000	60°/90°	>0.9	Aluminum	690*235*180
LED-YTLH-400W	400W	SMD3030	40000	60°/90°	>0.9	Aluminum	690*135*180
LED-YTLH-500W	500W	SMD3030	50000	60°/90°	>0.9	Aluminum	690*395*180
LED-YTLH-600W	600W	SMD3030	60000	60°/90°	>0.9	Aluminum	690*470*180

LED Stadium Light

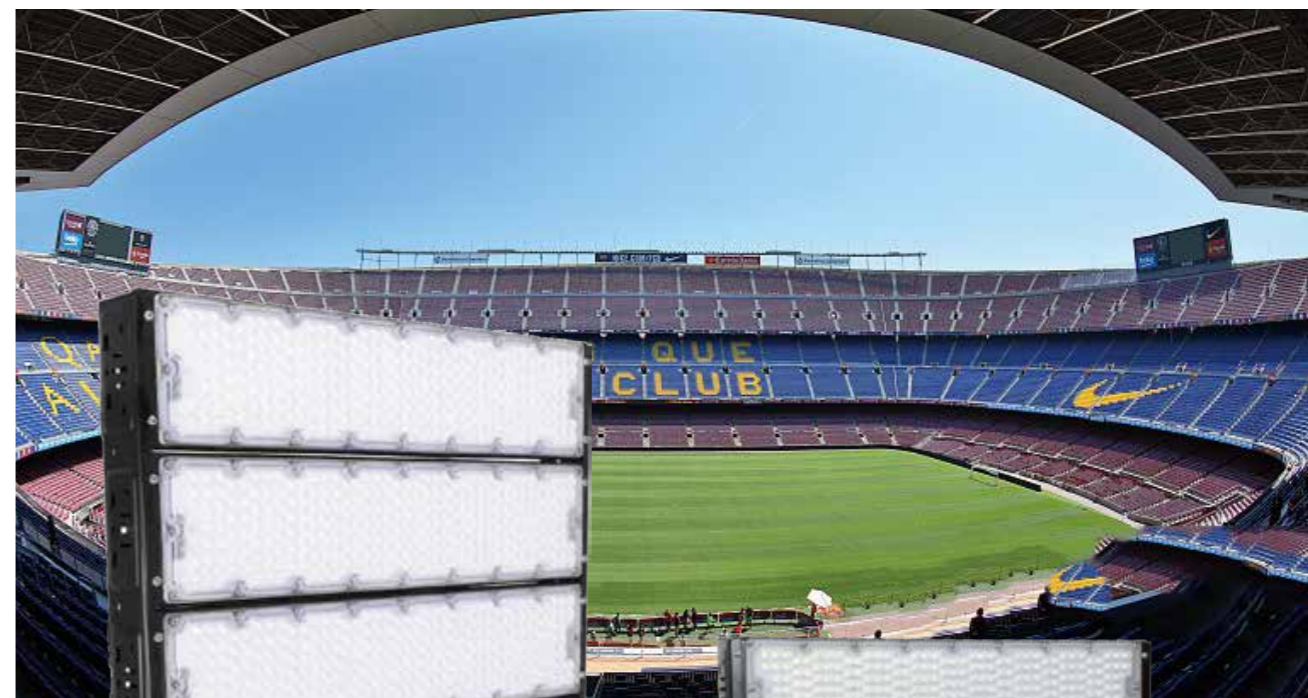

3000K 4000K 6500K

ITEM NO.	Wattage [W]	LED	Lumen [lm]	Beam angle	Power Factor	Material	Size [mm]
LED-YTLG-200W	200W	SMD3030	20000	30°/60°	>0.9	Aluminum	566*116*308
LED-YTLG-400W	400W	SMD3030	40000	30°/60°	>0.9	Aluminum	566*241*308
LED-YTLG-600W	600W	SMD3030	60000	30°/60°	>0.9	Aluminum	566*366*308
LED-YTLG-800W	800W	SMD3030	80000	30°/60°	>0.9	Aluminum	566*491*308
LED-YTLG-1000W	1000W	SMD3030	100000	30°/60°	>0.9	Aluminum	566*161*308

LED Stadium Light

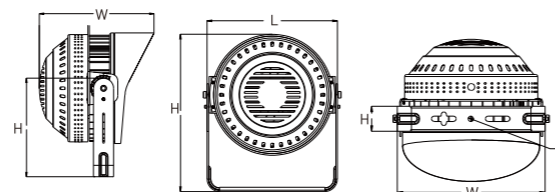
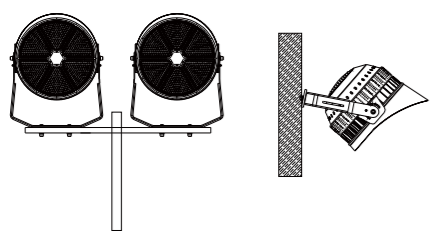

ITEM NO.	Wattage [W]	LED	Lumen [lm]	Beam angle	Power Factor	Material	Size [mm]
LED-TLE-200W	200W	3030SMD	28000	60°/90°	>0.9	Aluminum	355*342*429
LED-TLE-300W	300W	3030SMD	42000	60°/90°	>0.9	Aluminum	355*342*429
LED-TLE-400W	400W	3030SMD	55000	60°/90°	>0.9	Aluminum	481*453*500
LED-TLE-500W	500W	3030SMD	70000	60°/90°	>0.9	Aluminum	481*453*600
LED-TLE-600W	600W	3030SMD	84000	60°/90°	>0.9	Aluminum	481*453*600

LED Canopy Light



Surface Mounting Recessed installation

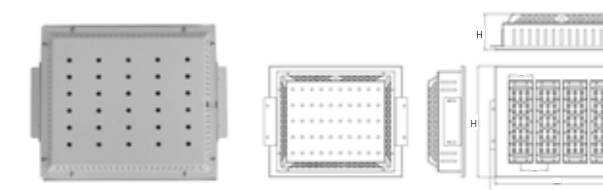
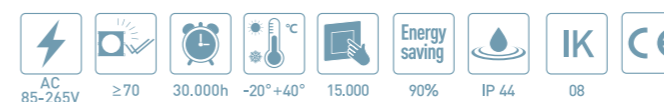

ITEM NO.	Wattage [W]	LED	Lumen [lm]	Beam angle	Power Factor	Material	Size [mm]
LED-CLA-100W	100W	SMD3030	12000	90°/90°	>0.9	Steel board	350*248*115
LED-CLA-150W	150W	SMD3030	18000	90°/90°	>0.9	Steel board	350*334*115
LED-CLA-200W	200W	SMD3030	24000	90°/90°	>0.9	Steel board	350*420*115

LED Garden Light

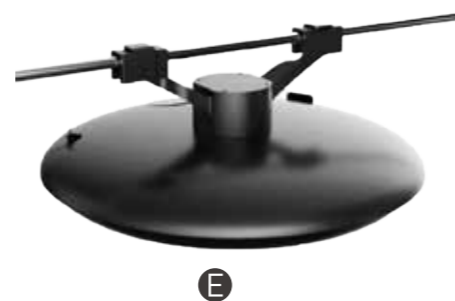

3000K 4000K 6500K

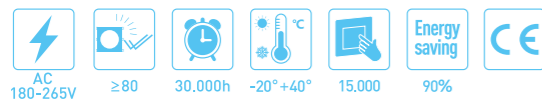

Item No.	Wattage [W]	LED	Lumen [lm]	Beam angle	Power Factor	Material	Pole Size [mm]	Size [mm]
LED-GLJ-30W(A/B/C/D/E)	30W	SMD3030	3600	Type II / Type III	>0.9	Aluminum	Ø60/76	Ø500*81.5
LED-GLJ-50W(A/B/C/D/E)	50W	SMD3030	6000	Type II / Type III	>0.9	Aluminum	Ø60/76	Ø500*81.5
LED-GLJ-60W(A/B/C/D/E)	60W	SMD3030	7200	Type II / Type III	>0.9	Aluminum	Ø60/76	Ø500*81.5
LED-GLJ-80W(A/B/C/D/E)	80W	SMD3030	9600	Type II / Type III	>0.9	Aluminum	Ø60/76	Ø500*81.5
LED-GLJ-100W(A/B/C/D/E)	100W	SMD3030	12000	Type II / Type III	>0.9	Aluminum	Ø60/76	Ø500*81.5
LED-GLJ-120W(A/B/C/D/E)	120W	SMD3030	14400	Type II / Type III	>0.9	Aluminum	Ø60/76	Ø500*81.5

LED Garden Light



3000K 4000K 6500K



Item No.	Wattage [W]	LED	Lumen [lm]	Beam angle	Power Factor	Material	Pole Size [mm]	Size [mm]
LED-GLK-50W	50W	SMD2835	5500	120	>0.9	Aluminum	Ø76	Ø467*565
LED-GLK-80W	80W	SMD2835	8800	120	>0.9	Aluminum	Ø76	Ø467*565
LED-GLK-100W	100W	SMD2835	11000	120	>0.9	Aluminum	Ø76	Ø467*565
LED-GLK-120W	120W	SMD2835	13200	120	>0.9	Aluminum	Ø76	Ø467*565
LED-GLK-150W	150W	SMD2835	16500	120	>0.9	Aluminum	Ø76	Ø467*565

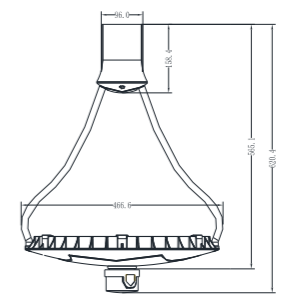

LED Garden Light



3000K 4000K 6500K

AC 85-265V ≥70 30,000h -20°+40° 15,000 90% IP 65 08

Energy saving

IK CE

ITEM NO.	Wattage [W]	LED	Lumen [lm]	Beam angle	Power Factor	Material	Pole Size(mm)	Size [mm]
LED-GLI-30W	30W	3030SMD	3600	120°	>0.9	Aluminum	60	D445*H590
LED-GLI-40W	40W	3030SMD	4800	120°	>0.9	Aluminum	60	D445*H590
LED-GLI-50W	50W	3030SMD	6000	120°	>0.9	Aluminum	60	D445*H590
LED-GLI-60W	60W	3030SMD	7200	120°	>0.9	Aluminum	60	D445*H590
LED-GLI-80W	80W	3030SMD	9600	120°	>0.9	Aluminum	60	D445*H590

LED Garden Light



3000K 4000K 6500K

AC 85-265V ≥70 30,000h -20°+40° 15,000 90% IP 65 08

Energy saving

IK CE

ITEM NO.	Wattage [W]	LED	Lumen [lm]	Beam angle	Power Factor	Material	Pole Size(mm)	Size [mm]
LED-GLH-30W	30W	3030SMD	3600	120°	>0.9	Aluminum	60	D450*H523
LED-GLH-40W	40W	3030SMD	4800	120°	>0.9	Aluminum	60	D450*H523
LED-GLH-50W	50W	3030SMD	6000	120°	>0.9	Aluminum	60	D450*H523
LED-GLH-60W	60W	3030SMD	7200	120°	>0.9	Aluminum	60	D450*H523
LED-GLH-80W	80W	3030SMD	9600	120°	>0.9	Aluminum	60	D450*H523

LED Garden Light

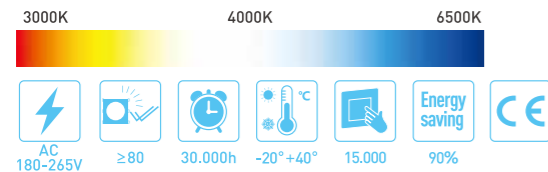
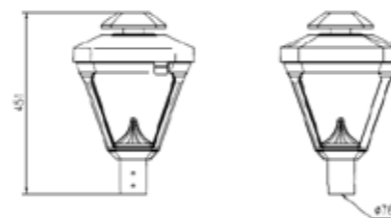
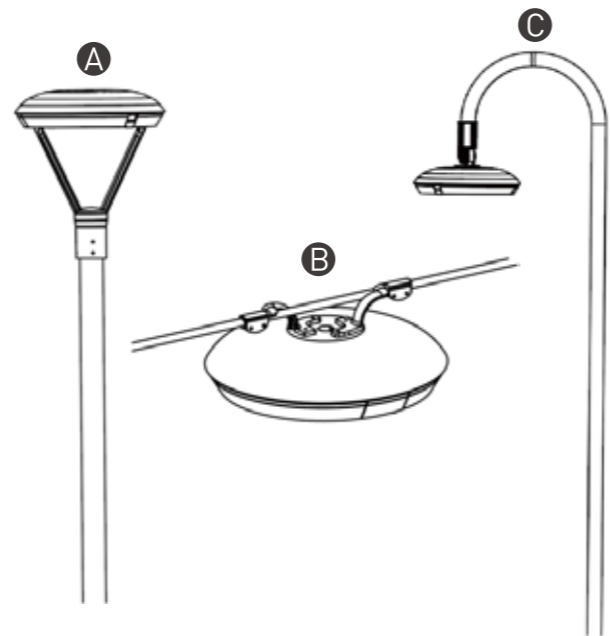

Item No.	Wattage [W]	LED	Lumen [lm]	Beam angle	Power Factor	Material	Pole Size [mm]	Size [mm]
LED-GLM-30W(A/B/C)	30W	SMD3030	3900	Type II / TypeIII	>0.9	Aluminum	Ø76	323*323*407
LED-GLM-40W(A/B/C)	40W	SMD3030	5200	Type II / TypeIII	>0.9	Aluminum	Ø76	323*323*407
LED-GLM-50W(A/B/C)	50W	SMD3030	6500	Type II / TypeIII	>0.9	Aluminum	Ø76	323*323*407
LED-GLM-60W(A/B/C)	60W	SMD3030	7800	Type II / TypeIII	>0.9	Aluminum	Ø76	323*323*407
LED-GLM-80W(A/B/C)	80W	SMD3030	10400	Type II / TypeIII	>0.9	Aluminum	Ø76	485*485*546
LED-GLM-100W(A/B/C)	100W	SMD3030	13000	Type II / TypeIII	>0.9	Aluminum	Ø76	485*485*546
LED-GLM-120W(A/B/C)	120W	SMD3030	15600	Type II / TypeIII	>0.9	Aluminum	Ø76	485*485*546
LED-GLM-150W(A/B/C)	150W	SMD3030	19500	Type II / TypeIII	>0.9	Aluminum	Ø76	485*485*546

LED Garden Light

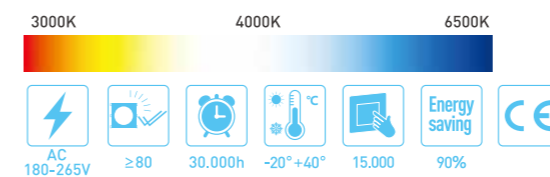
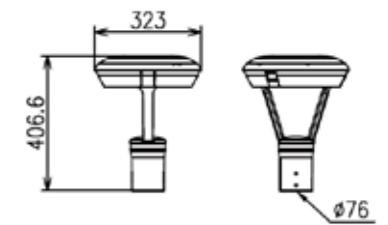
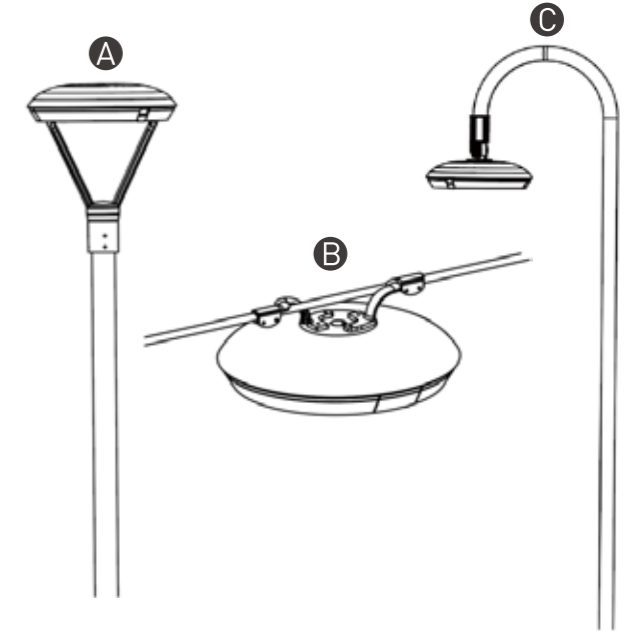

Item No.	Wattage [W]	LED	Lumen [lm]	Beam angle	Power Factor	Material	Pole Size [mm]	Size [mm]
LED-GLL-30W(A/B/C)	30W	SMD3030	3900	Type II / TypeIII	>0.9	Aluminum	Ø76	300*300*451
LED-GLL-40W(A/B/C)	40W	SMD3030	5200	Type II / TypeIII	>0.9	Aluminum	Ø76	300*300*451
LED-GLL-50W(A/B/C)	50W	SMD3030	6500	Type II / TypeIII	>0.9	Aluminum	Ø76	300*300*451
LED-GLL-60W(A/B/C)	60W	SMD3030	7800	Type II / TypeIII	>0.9	Aluminum	Ø76	300*300*451
LED-GLL-80W(A/B/C)	80W	SMD3030	10400	Type II / TypeIII	>0.9	Aluminum	Ø76	478*478*613
LED-GLL-100W(A/B/C)	100W	SMD3030	13000	Type II / TypeIII	>0.9	Aluminum	Ø76	478*478*613
LED-GLL-120W(A/B/C)	120W	SMD3030	15600	Type II / TypeIII	>0.9	Aluminum	Ø76	478*478*613
LED-GLL-150W(A/B/C)	150W	SMD3030	19500	Type II / TypeIII	>0.9	Aluminum	Ø76	478*478*613

LED Garden Light



Photocell sensor unit (optional), according to environmental illumination to auto control turn on/off, energy saving and environmental protection.



- AC 85-265V
- ≥70
- 30,000h
- 20°+40°
- 15,000
- 90%
- IP 65
- IK 08
- CE

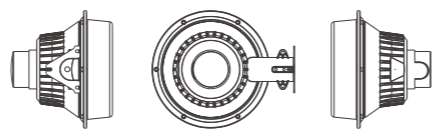

ITEM NO.	Wattage [W]	LED	Lumen [lm]	Beam angle	Power Factor	Material	Size [mm]
LED-YGLN-50W	50W	SMD2835	5500	120°	>0.9	Aluminum	295*242*156

LED Garden Light

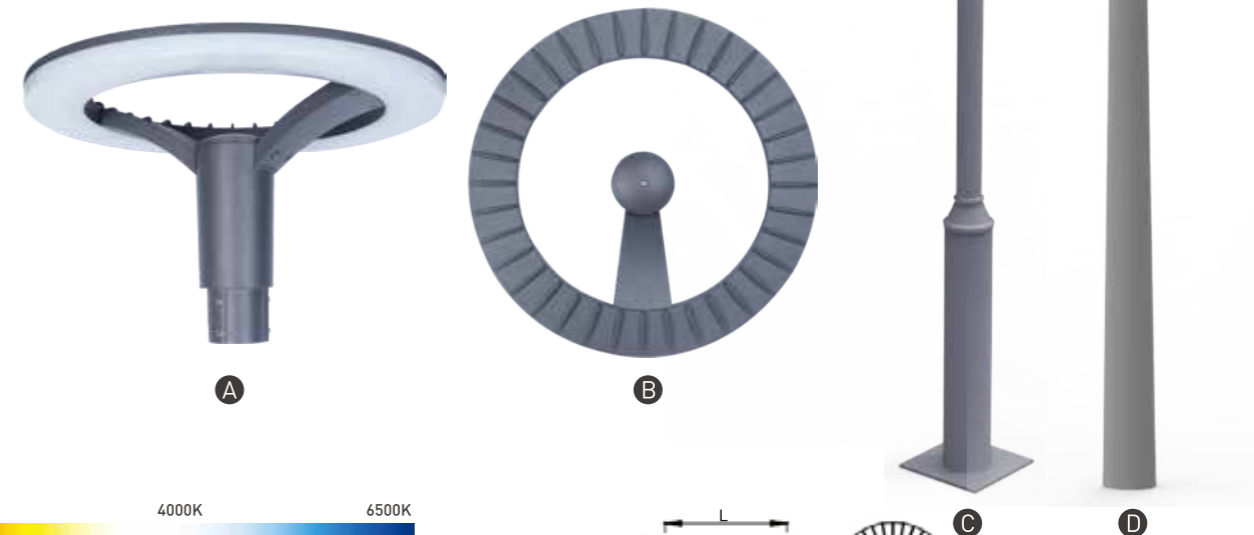

- AC 85-265V
- ≥70
- 30,000h
- 20°+40°
- 15,000
- 90%
- IP 65
- IK 08
- CE

ITEM NO.	Wattage [W]	LED	Lumen [lm]	Beam angle	Power Factor	Material	Size [mm]
LED-GL-30W(A/B/C/D)	30W	SMD3030	2400	100°	>0.9	Aluminum	D520*H317
LED-GL-45W(A/B/C/D)	45W	SMD3030	3600	100°	>0.9	Aluminum	D520*H317
LED-GL-60W(A/B/C/D)	60W	SMD3030	4800	100°	>0.9	Aluminum	D520*H317
LED-GL-80W(A/B/C/D)	80W	SMD3030	6400	100°	>0.9	Aluminum	D520*H317

LED Garden Light



ITEM NO.	Wattage [W]	LED	Lumen [lm]	Beam angle	Power Factor	Material	Pole Size[mm]	Size [mm]
LED-GLA-40W	40W	SMD3030	3200	150°	>0.9	Aluminum	76	D690*H482
LED-GLA-60W	60W	SMD3030	4800	100°	>0.9	Aluminum	76	D690*H482
LED-GLC-30W	30W	SMD3030	2400	90°	>0.9	Aluminum	76	D440*H620
LED-GLC-45W	45W	SMD3030	3600	90°	>0.9	Aluminum	76	D440*H620
LED-GLC-60W	60W	SMD3030	4800	90°	>0.9	Aluminum	76	D440*H620

LED Garden Light



ITEM NO.	Wattage [W]	LED	Lumen [lm]	Beam angle	Power Factor	Material	Pole Size[mm]	Size [mm]
LED-GLB-26W	26W	SMD3030	1820	150°	>0.9	Aluminum	76	D370*497
LED-GLB-36W	36W	SMD3030	2520	100°	>0.9	Aluminum	76	D370*497
LED-GLG-30W	30W	SMD3030	2700	90°	>0.9	Aluminum	76	D605*H883
LED-GLG-45W	45W	SMD3030	4050	93°	>0.9	Aluminum	76	D605*H883
LED-GLG-60W	60W	SMD3030	5400	100°	>0.9	Aluminum	76	D605*H883

LED Garden Light



LED-GLD-*W

LED-GLE-*W

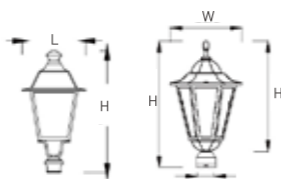

ITEM NO.	Wattage [W]	LED	Lumen [lm]	Beam angle	Power Factor	Material	Pole Size[mm]	Size [mm]
LED-GLD-30W	30W	SMD3030	1800	118°	>0.9	Aluminum	76	400*400*770
LED-GLD-45W	45W	SMD3030	2700	118°	>0.9	Aluminum	76	400*400*770
LED-GLD-60W	60W	SMD3030	3600	125°	>0.9	Aluminum	76	400*400*770
LED-GLE-26W	26W	SMD3030	1820	150°	>0.9	Aluminum	76	D320*H573
LED-GLE-36W	36W	SMD3030	2520	100°	>0.9	Aluminum	76	D320*H573

LED Garden Light

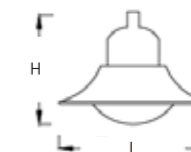
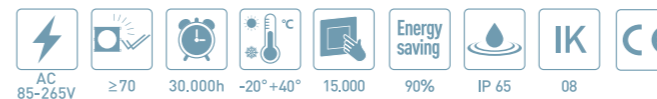

ITEM NO.	Wattage [W]	LED	Lumen [lm]	Beam angle	Power Factor	Material	Size [mm]
LED-GLF-30W	30W	SMD3030	2400	80°	>0.9	Aluminum	D560*H370
LED-GLF-45W	45W	SMD3030	3600	80°	>0.9	Aluminum	D560*H370
LED-GLF-60W	60W	SMD3030	4800	80°	>0.9	Aluminum	D560*H370